









**LEGEND**





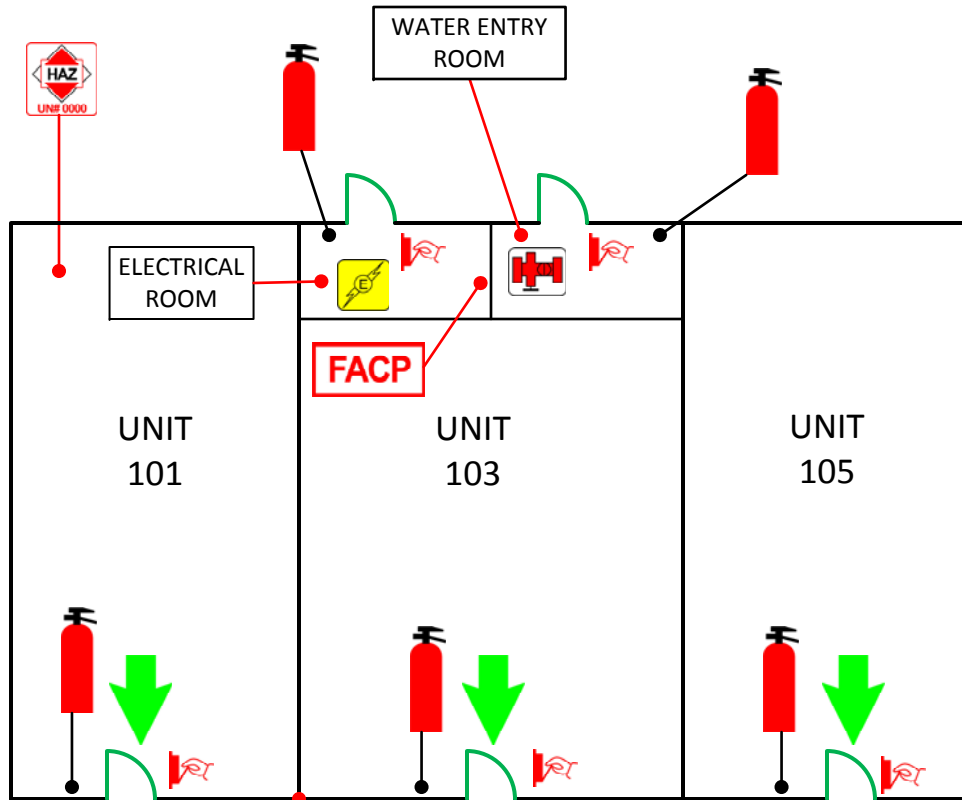
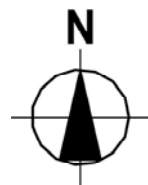

-  FIRE EXT
-  EXIT
-  PULL STN
-  ELEC RM
-  SPRINK S/O
-  F/A ANNUN PANEL
-  F/A CTRL PANEL
-  HAZ MTRLS



**FIRE SAFETY  
PLAN EXAMPLE**



**LEGEND**

-  FF ENTRY PT
-  ELEC RM
-  SPRINK S/O
-  F/A ANNUN PANEL
-  F/A CTRL PANEL
-  HAZ MTRLS

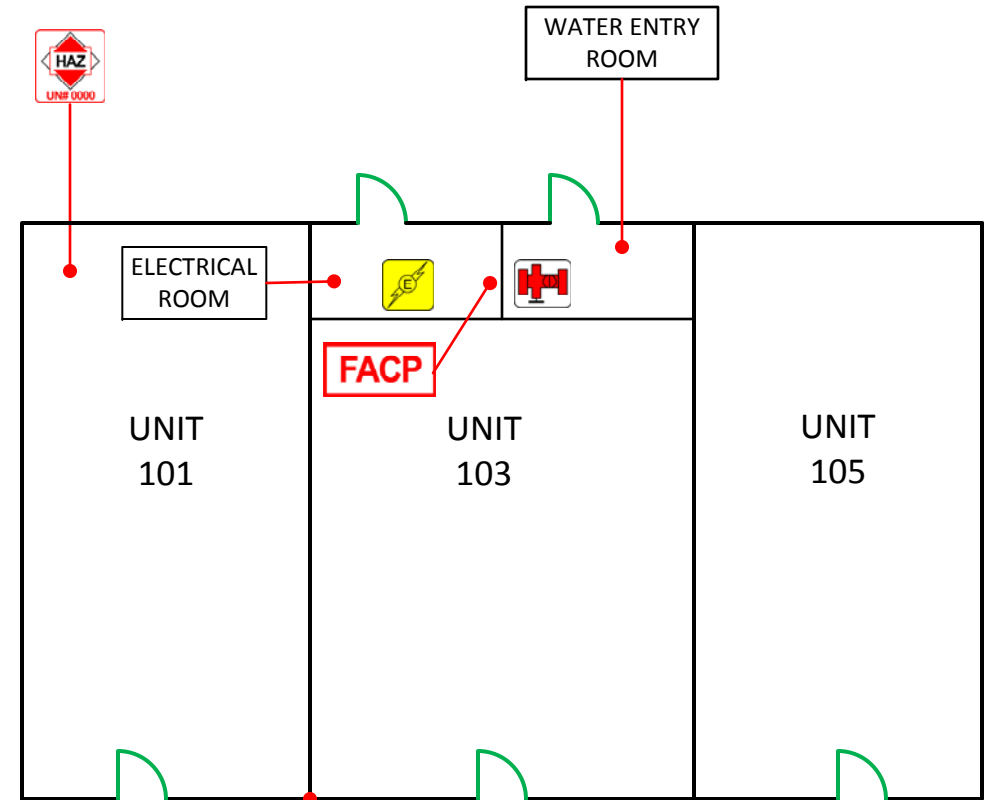

**PRE-INCIDENT  
PLAN EXAMPLE**

