

City of Coquitlam

Maillardville Streetscape Guidelines

*Respecting the past,
looking to the future*

Table of Contents

1.0	Introduction	1
1.1	Streetscapes Guidelines for Engaging, Heritage-Inspired, Pedestrian-Friendly Places	1
1.2	Development and Alignment with Other City Documents	1
1.3	Adjoining Streetscapes	3
1.4	How to Use these Guidelines	3
2.0	Streetscape Design Principles	5
3.0	Streetscape Zones	6
4.0	Streetscape Design: Character Areas, Greenways and Processional Route	8
4.1	Character Areas: Maillardville Neighbourhood Centre	12
4.1.1	Commercial Frontage	15
4.1.2	Residential Frontage: Local Road - High Density	20
4.1.3	Residential Frontage: Local Road – Low Density	24
4.2	Heritage Character Areas: Laval Square and Allard-LeBleu	28
4.2.1	Laval Square	32
4.2.2	City Arterial Street - Residential Frontage	35
4.2.3	Local Residential Street	38
4.3	Greenways	40
4.3.1	Neighbourhood Greenways	43
4.3.2	Greenway Parkette Type 1, Arterial and Local Street Intersection	45
4.3.3	Greenway Parkette Type 2, Local Street Intersection	47
4.4	Processional Route	50
5.0	Streetscape Details	53
5.1	Paving Materials	54
5.2	Site Furnishing	56
5.2.1	Bench Type 1	59
5.2.2	Bench Type 2	60
5.2.3	Bicycle Rack Type 1	61
5.2.4	Bicycle Rack Type 2	61
5.2.5	Litter Receptacle Type 1	62
5.2.6	Heritage Inspired Fire Hydrant	62
5.2.7	Bollards	63
5.2.8	Tree Grate	63
5.2.9	Planter Box Type 1	64
5.2.10	Planter Box Type 2	65

5.3 Street Trees and Landscaping	66
5.3.1 Brunette Avenue Plantings	69
5.3.2 Maillardville Neighbourhood Centre - Commercial Frontage	70
5.3.3 Maillardville Neighbourhood Centre - Residential Frontage	70
5.3.4 Laval Square Character Area Plantings	72
5.3.5 Allard-LeBleu Character Area Plantings	73
5.3.6 Parkette Plantings and Tree Selection	74
5.3.7 Rain Garden Plantings	75
5.4 Lighting	77
5.4.1 Street Type 1	78
5.4.1 Street Type 2	80
5.4.2 Pedestrian	81
5.5 Street Name Signs	82



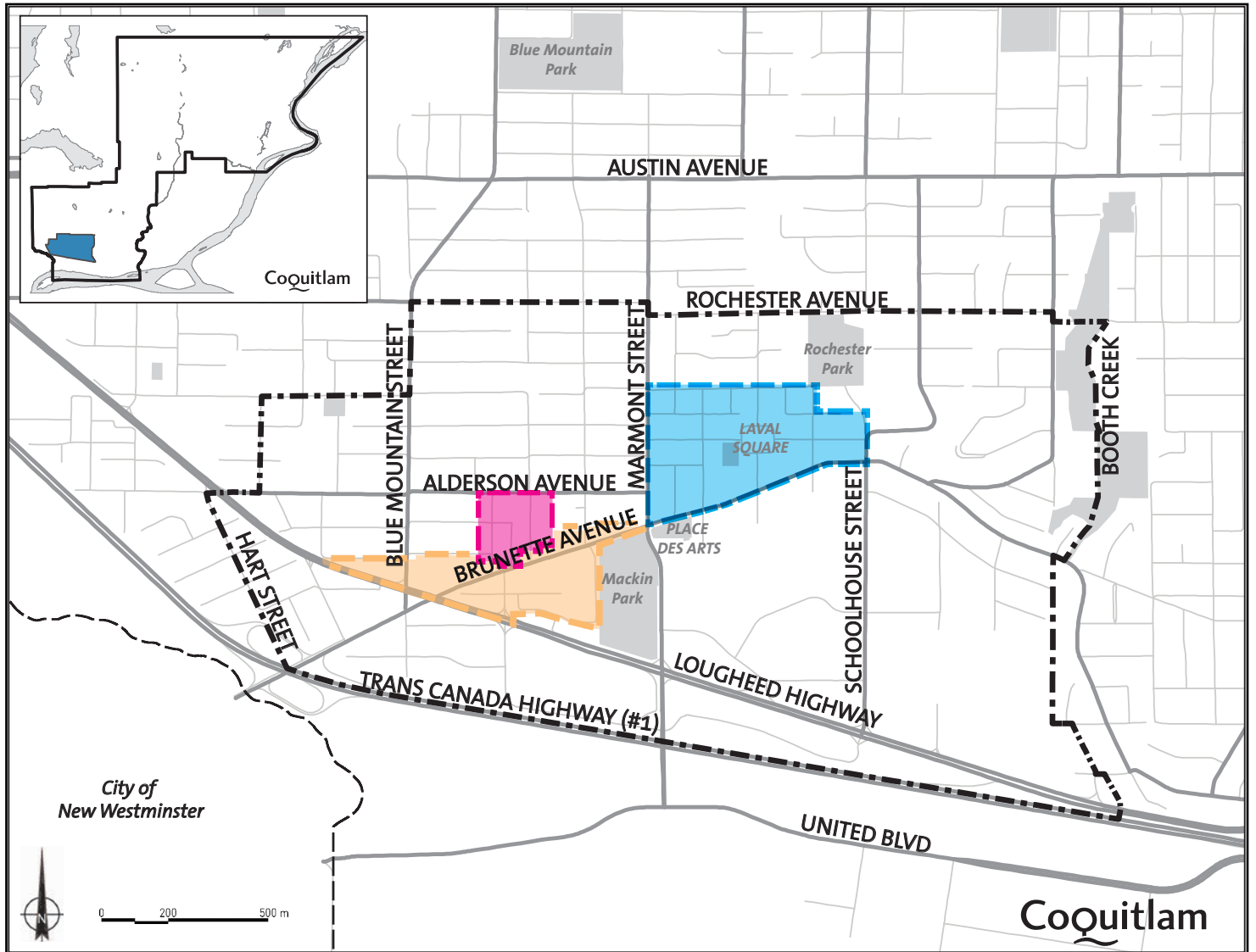

Image-1 Maillardville Neighbourhood Plan Location

NEIGHBOURHOOD CHARACTER AREAS

-  Maillardville Neighbourhood Centre
-  Allard-LeBleu Area
-  Laval Square Area

1.0 Introduction

1.1 Streetscape Guidelines for Engaging, Heritage-Inspired and Pedestrian-Friendly Places

The Maillardville Streetscape Guidelines have been developed to help implement the Maillardville Neighbourhood Plan (MNP), and will guide the development of engaging, heritage-inspired and pedestrian-friendly streetscapes within key MNP ‘Character Areas’ and pedestrian routes. These Guidelines aim to enhance Maillardville’s unique history and character as the neighbourhood continues to grow and evolve, and are to be applied within the Laval Square, Allard-LeBleu and Neighbourhood Centre Character Areas, as well as along future Neighbourhood Greenways and the ‘Processional Route’.

For this document, streetscapes are defined as the ‘frontage’ areas between street curbs and developments along public street right-of-ways, which include boulevards, sidewalks and other pedestrian-oriented areas.

These Guidelines provide a ‘kit of parts’, to be used when developers or the City construct new developments adjacent to applicable street right-of-ways, by illustrating general streetscape layouts (based on adjacent land uses) and identifying appropriate pavement materials, street furniture (ie. benches) and lighting types.

Through a series of maps, the Guidelines also identify the neighbourhood locations for specific streetscape designs, materials, street tree and lighting types, as well as ‘parkette’ locations (small planted seating areas at key intersections) along the Neighbourhood Greenways. The final chapter of these Guidelines contains the ‘details’, including a comprehensive set of specific street trees, plantings, street furniture and lighting fixtures that developers can choose from when constructing new streetscape areas that follow the design intent of these Guidelines.

1.2 Development and Alignment with Other City Documents

The Maillardville Streetscape Guidelines document is the culmination of a consultation process involving input from various City departments, City advisory committees and the general public. This document’s intended audience is diverse, consisting of design professionals, City staff, community groups, private developers and members of the public. The Maillardville Streetscape Guidelines are a component of the City’s planning framework and a companion document that supplements rather than replaces existing engineering, environmental and design standards, requirements, or guidelines, such as the Maillardville Neighbourhood Plan, the Development Permit Design Guidelines and the Subdivision and Development Servicing Bylaw.

In a neighbourhood with as many varied and complex conditions as Maillardville, designs must be tailored to the particular needs and opportunities created by the local context, uses, heritage values, distinct character and street dimensions. The Maillardville Streetscape Guidelines leave ample room for choice, and all designs remain subject to City approval based on established engineering standards and professional judgment, with the safety of all street users being of paramount importance.



The best streets are those that can be remembered. They leave strong, long-continuing positive impressions. Thinking of a city, including one’s own, one might well think of a particular street and have a desire to be there; such a street is memorable.

– Alan Jacobs



Image-2 Processional along Brunette Avenue - c. 1913

1.3 Adjoining Streetscapes

Where the street right-of-way is located along the boundaries of a Maillardville character area identified in this document, the opposite side of the street, outside of the Character Area, should adopt the higher standard streetscape character as defined by these guidelines. This is to ensure a contiguous streetscape aesthetic and avoid differences from one side of a street to the other.

Except as noted in this document, areas outside the boundaries of where these streetscape guidelines apply are guided by the standard City of Coquitlam's Subdivision and Development Servicing Bylaw and other City standards and requirements.

1.4 How to Use these Guidelines

These guidelines are to be used as part of the design and review of works and services (or more commonly known as frontage improvements) for streetscapes in key areas of Maillardville. When beginning a design or review process, use the following progression:

Step 1 Review the Streetscape Design Principles (Section 2.0) and Zones (Section 3.0) to ensure streetscape designs conform to the goal of achieving great streetscapes in Maillardville.

Step 2 Use Section 4.0 Streetscape Design: Character Areas, Greenways and Processional Routes to determine if the subject property is within or across the street from one of the "Character Areas", as identified on Figure-3 (page 9), along a "Greenway" or adjacent to a "Parkette", as identified on Figure-24 (page 41), or on the Processional Route as identified on Figure-31 (page 51).

Step 3 Use Section 5.0 Streetscape Details (text and maps) to determine paving materials (Section 5.1), furnishings, including colour (Section 5.2), street trees and landscaping (Section 5.3), lighting requirements (Section 5.4) and enhanced streetscape infrastructure (Section 5.5).

It is possible for applicants/developers to propose streetscape elements beyond the minimum provisions set out for each frontage type, and in some cases, the City may request additional elements on a case-by-case basis, as deemed appropriate by the General Manager Planning and Development.

Should a conflict exist between the application of the Streetscape Elements identified in this document and typical City standards, these guidelines take precedence.

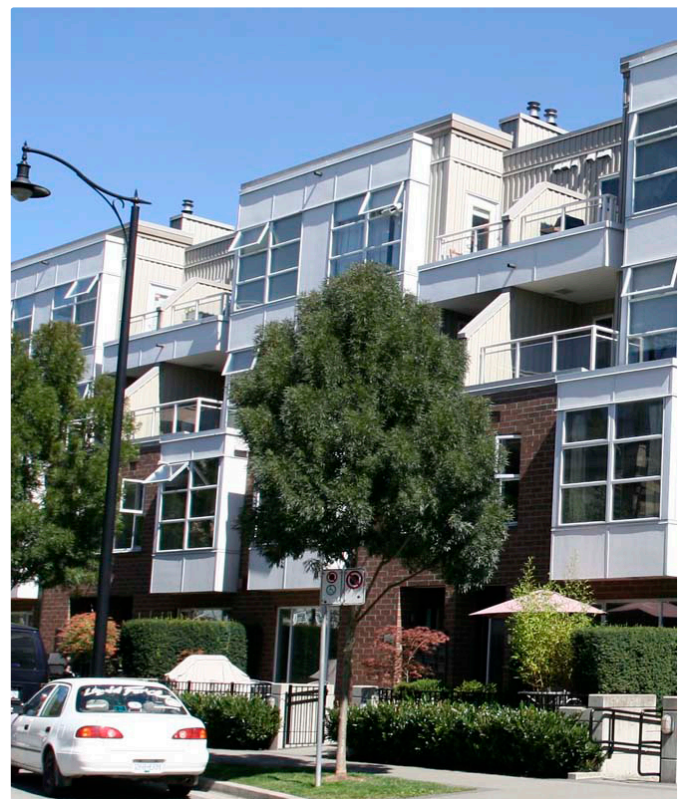

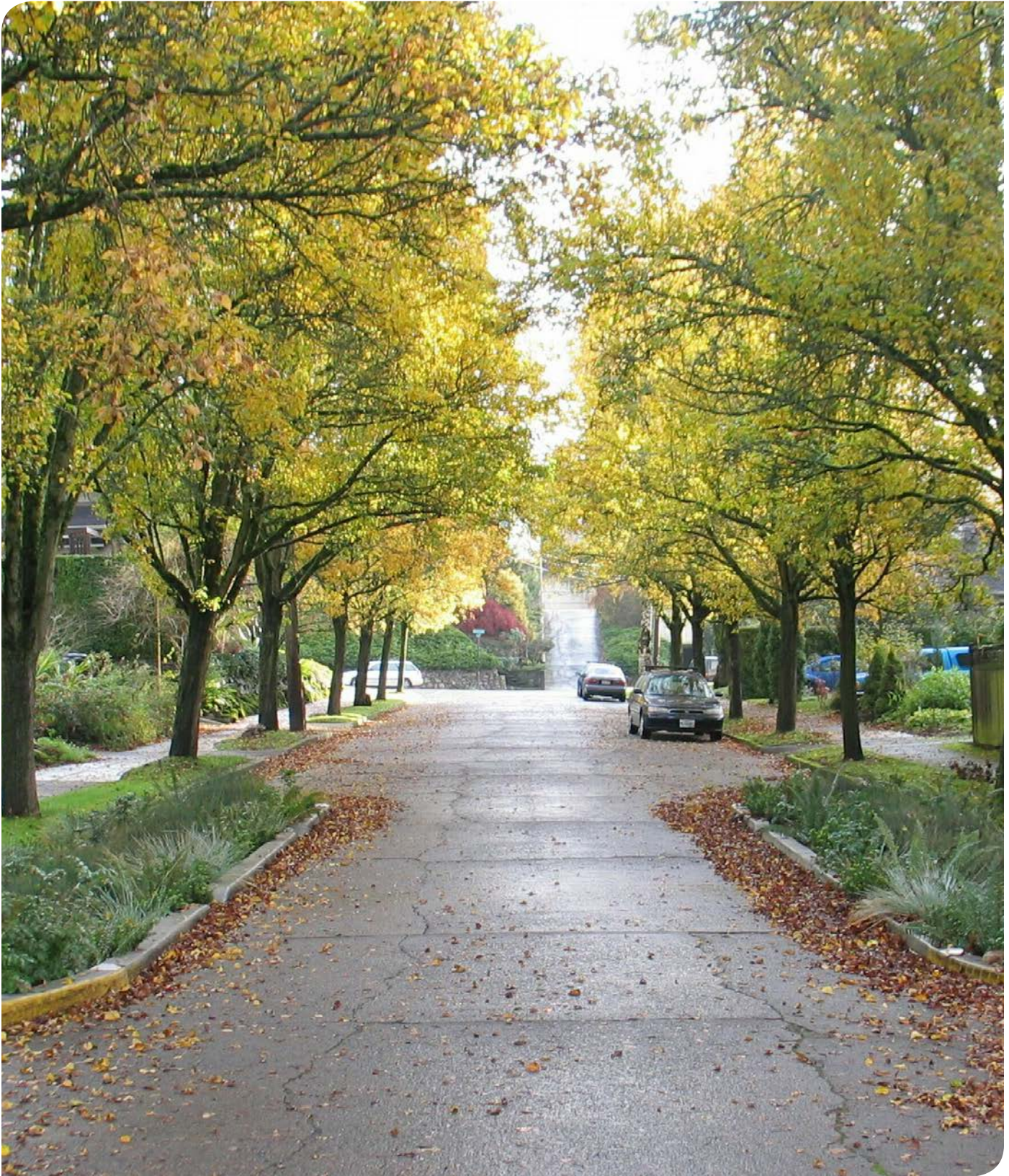

Image-3 Demonstrates a Local Residential Street with On-Street Parking and Rain Garden

2.0 Streetscape Design Principles

The Maillardville Streetscape Guidelines will guide design efforts to create pedestrian-friendly character and desirable and livable streetscapes in key areas of Maillardville. Streetscape design principles have been developed to complement the Maillardville Neighbourhood Plan vision, guiding principles and policies and the design intentions of the Development Permit Design Guidelines for Maillardville, with the goal of celebrating heritage and reinforcing unique character. These design principles are stated in general terms and address the fundamental aspects of achieving great streets in Maillardville. Design efforts should:

- Create streetscapes that foster a distinct sense of place and neighbourhood identity
- Create desirable streets that contribute to the economic success of local business and the livability residential areas
- Create streetscapes that maximize the quality of experience, comfort, safety and universal access for pedestrians while maintaining a balance between all users
- Create streetscapes that are visually and functionally cohesive
- Create streetscapes that celebrate the historical context of Maillardville in an honest and stylistically true manner
- Create streetscapes that anticipate long term phasing of improvements that allows for incremental character enrichment and community development over time
- Create streetscape that are easy to maintain, have long-lasting quality, durability and timelessness



Image-4 Demonstrates an Enhanced Pedestrian Area



Image-5 Demonstrates Prominent Street Tree Planting

3.0 Streetscape Zones

For the purpose of these Guidelines, the streetscape is defined as the area in the road right-of-way, between the curb, next to vehicle travel lanes, and the property line, or building face, where the streetscape treatment extends onto private property. More specifically, the streetscape consists of several zones that serve different functions:

- **Curb Zone** (including the potential for ‘parking pockets’ in commercial areas);
- **Furnishings or Boulevard Zone** (determined by adjacent land use);
- **Pedestrian Movement Zone**; and
- **Building Frontage Zone**.

Curb Zone

The Curb Zone includes transit stops, barrier curbs, letdowns for pedestrian and vehicle traffic and gutters to convey rain water to drains and rain gardens where applicable. This Zone also accommodates parking pockets in commercial areas.

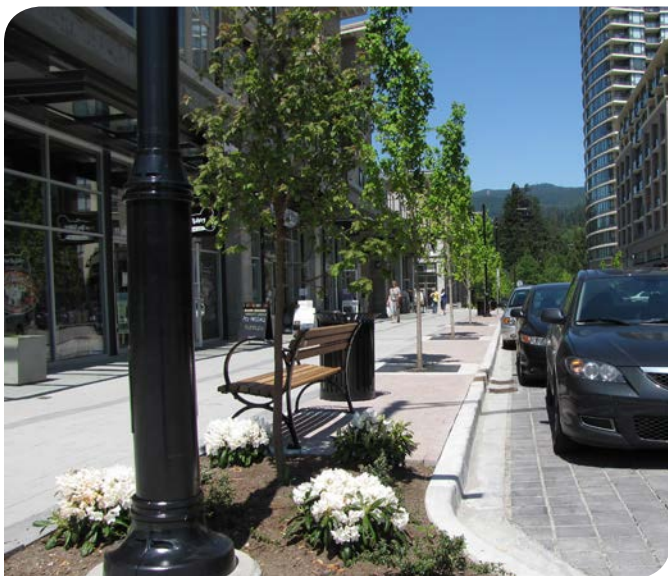

Image-6 Demonstrates an example of a Commercial Streetscape Corridor

Furnishings Zone (applies to Commercial or Higher Density Residential Streetscapes)

The Furnishings Zone is the strip adjacent to and between the Curb Zone and the Pedestrian Movement Zone. It buffers pedestrians from the adjacent roadway and is the area where streetscape amenities, such as benches, transit shelters, bike racks, and elements that could be an obstacle to pedestrian movement are located. Physically separating pedestrians from vehicle travel lanes greatly increases their comfort and this buffering function is especially important on streets where vehicular traffic is heavy, traffic speeds are higher and where on-street parking does not exist.

Boulevard Zone (applies to Low Density Residential Streetscapes)

The Boulevard Zone is similar to the Furnishings Zone. It is the strip adjacent to the curb that buffers pedestrians from the adjacent roadway. In this setting it is typically vegetated with grass or planting but continues to contain the various street elements that would otherwise impede pedestrian movement. In some instances it can include paving and site furniture such as bike racks or seating.

Pedestrian Movement Zone

The Pedestrian Movement Zone is the area intended for pedestrian travel and therefore should be obstacle free, continuous, uniform and predictably located within the streetscape corridor between the Furnishings/Boulevard and the Building Frontage Zones. This zone also supports universal access.

Building Frontage Zone

The Building Frontage Zone is the area between the Pedestrian Movement Zone and the property line or building face. A variety of elements, such as litter receptacles and planter boxes, and activities, such as merchandise displays and café seating, are encouraged within this zone to promote an active street frontage.

Figure-1 Streetscape Zones: Commercial or Higher Density Residential Streetscape Corridor

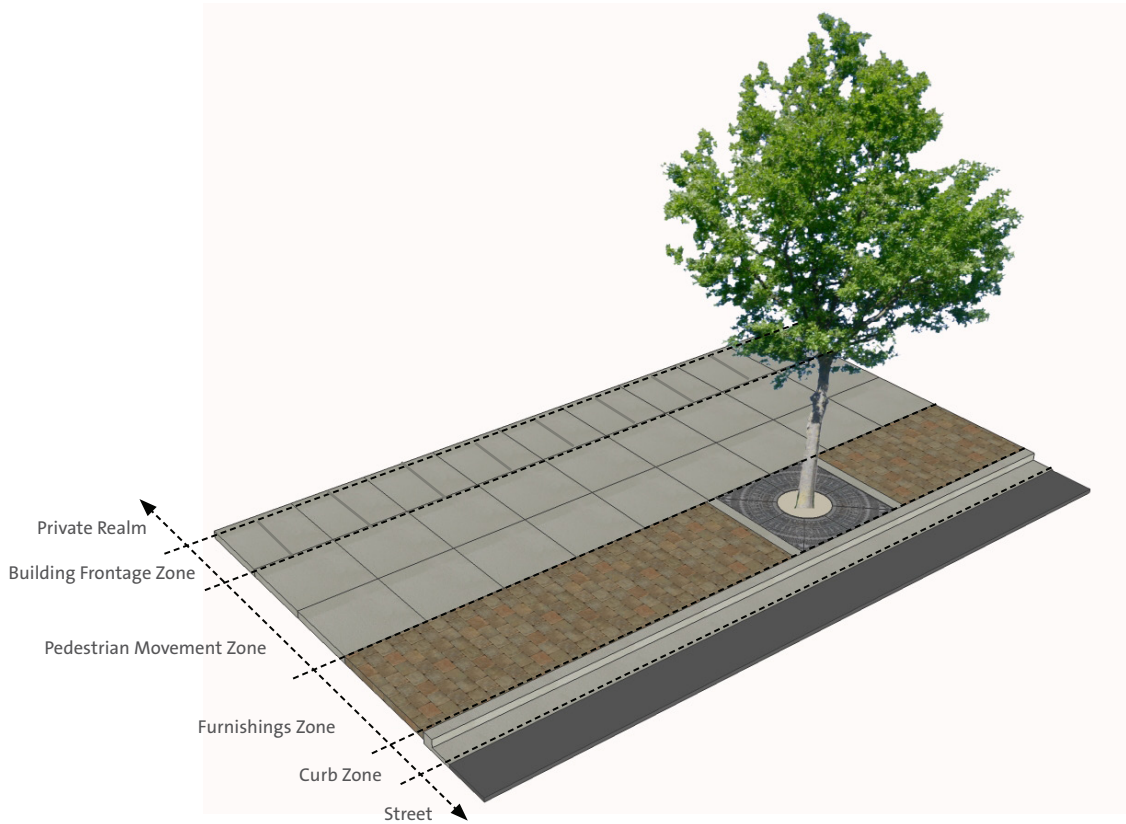
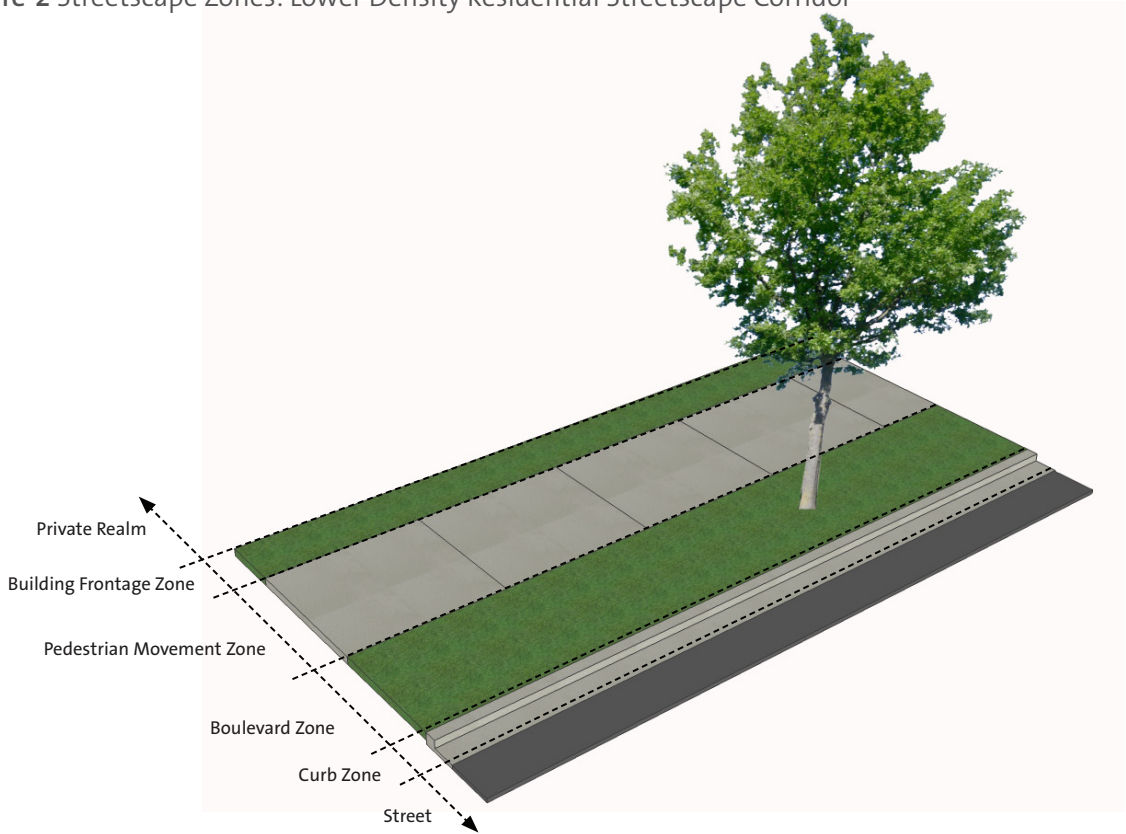

Figure-2 Streetscape Zones: Lower Density Residential Streetscape Corridor



4.0 Streetscape Design: Character Areas, Greenways and Processional Route

The streetscape guidelines in this document apply to streets in key character areas, neighbourhood greenways and a 'processional route' in Maillardville. This typology responds to both existing conditions and anticipated changes, allowing areas and streets to be differentiated from each other yet coordinated with the streetscape design principles, resulting in overall clarity, continuity, legibility, and memorability of Maillardville.

Character Areas

The Maillardville Neighbourhood Plan identifies the following three distinct 'Character Areas' (shown on Figure 3) that each have a specific set of streetscape design requirements different from the typical City standard.

- Maillardville Neighbourhood Centre;
- Allard-LeBleu; and
- Laval Square Area

The Maillardville Neighbourhood Centre will become the mixed-use neighbourhood 'heart' with a pedestrian-friendly 'Main Street' populated by local-serving shops along Brunette Avenue. Allard-LeBleu and Laval Square are particularly unique heritage precincts and historic 'town-sites' that contain distinct land patterns and heritage buildings.

The intent of these special requirements is to unify each 'Character Area' as a part of Maillardville but also establish a subtle sense of uniqueness that reflects the different land use context.

Neighbourhood Greenways

A Greenway system, as defined by the Strategic Transportation Plan and the Maillardville Neighbourhood Plan, traverses the three character areas, connecting the community with a dedicated multi-modal pathway (shown on Figure 24: page 41). These guidelines provide specific design guidelines, as identified in the MNP, for the Maillardville 'neighbourhood' specific greenways, establishing a distinct aesthetic and character to identify it as a multi-modal route that is different from the standard sidewalk. Furthermore, this visual difference helps to promote non-vehicle movement within Maillardville and the City of Coquitlam. The unique character also helps to identify to cyclists and pedestrians that they have arrived in Maillardville from adjacent portions of the City.

Design guidelines for the Citywide portion of the Maillardville greenway network will be developed under a separate functional design exercise that will draw upon the 'kit of parts' found in this document.

Processional Route

To echo community history these Streetscape Guidelines also recognize and celebrate a historic '*processional route*' connecting Laval Square with the revitalized social and economic centre of the community at the Neighbourhood Centre (shown on Figure 31: page 51). This route uses a different colour finishing (Black) for street furniture and lighting, supplemented with banner, hanging flower basket and seasonal lighting infrastructure to identify it as a historic ceremonial pedestrian route.

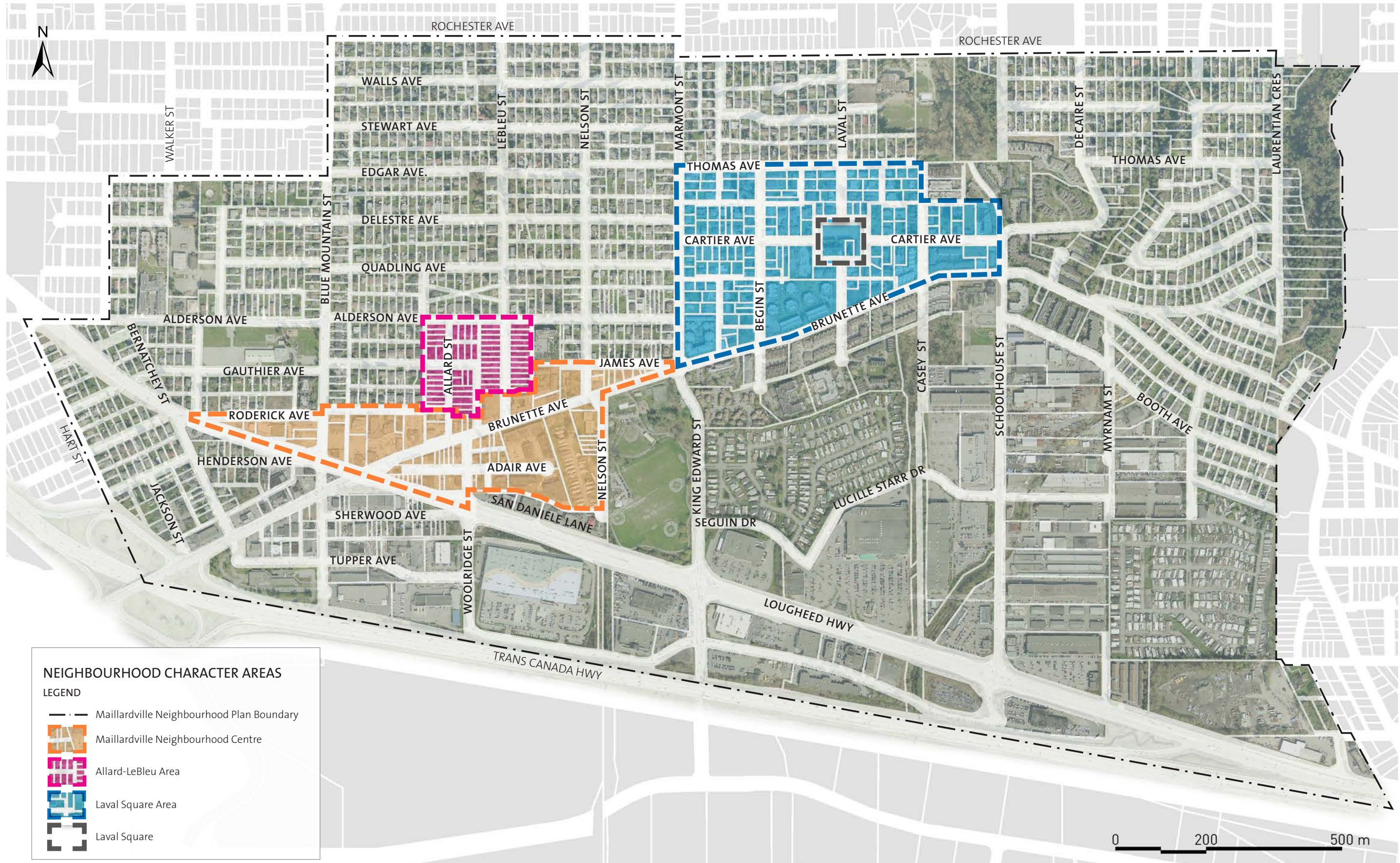

Figure-3 Neighbourhood & Character Areas

This page intentionally left blank



Image-7 Demonstrates a Commercial Frontage Patio Culture

4.1 Character Areas

Maillardville Neighbourhood Centre

The Maillardville Neighbourhood Centre is the commercial/retail core east of the intersection of Lougheed Highway and Brunette Avenue. As the social and economic heart of the community with higher residential densities it warrants a greater level of detail and elements to support the increased use and demands. The Neighbourhood Centre is comprised of two street frontage types associated with the designated land use: (1) Commercial and (2) Residential, as identified on Figure-4.

Improvements to the streetscape within the Neighbourhood Centre will follow the guidelines set out in this document, as differentiated and further described by street frontage type and road classification in the sections to follow.

Design Intent

- Create a rhythm of streetscape design elements so users realize they are in a special place.
- Develop a unified street frontage character along Brunette Avenue and through to Laval Square.
- Provide site furniture elements that promote walking and cycling.
- Create a series of places along commercial frontage sidewalks to facilitate social interaction, business activity and patio culture.
- Maximize the width of the 'pedestrian movement zone' along commercial frontages and integrate small bump-outs for patios or distinct paving related to business entrances.
- Provide on-street parking pockets with planted bump-outs wherever possible along commercial streets.
- Recognize the historic 'processional route' linking the Neighbourhood Centre and Laval Square. Provide the necessary infrastructure for hanging baskets and banners to help mark the route and create a unique identity.
- Integrate the clock tower, gateway plaza and streetscape as an integral part of adjacent development site(s).
- Ensure build-out results in unified streetscapes by requiring development that faces parcels designated for higher density/character to build the streetscape to the higher streetscape standard character. This extends to streetscapes outside of the character area such as the north side of Roderick and James Avenues (with some exceptions).
- Underground overhead wires, wherever possible, to improve the visual and physical condition of Brunette Avenue.

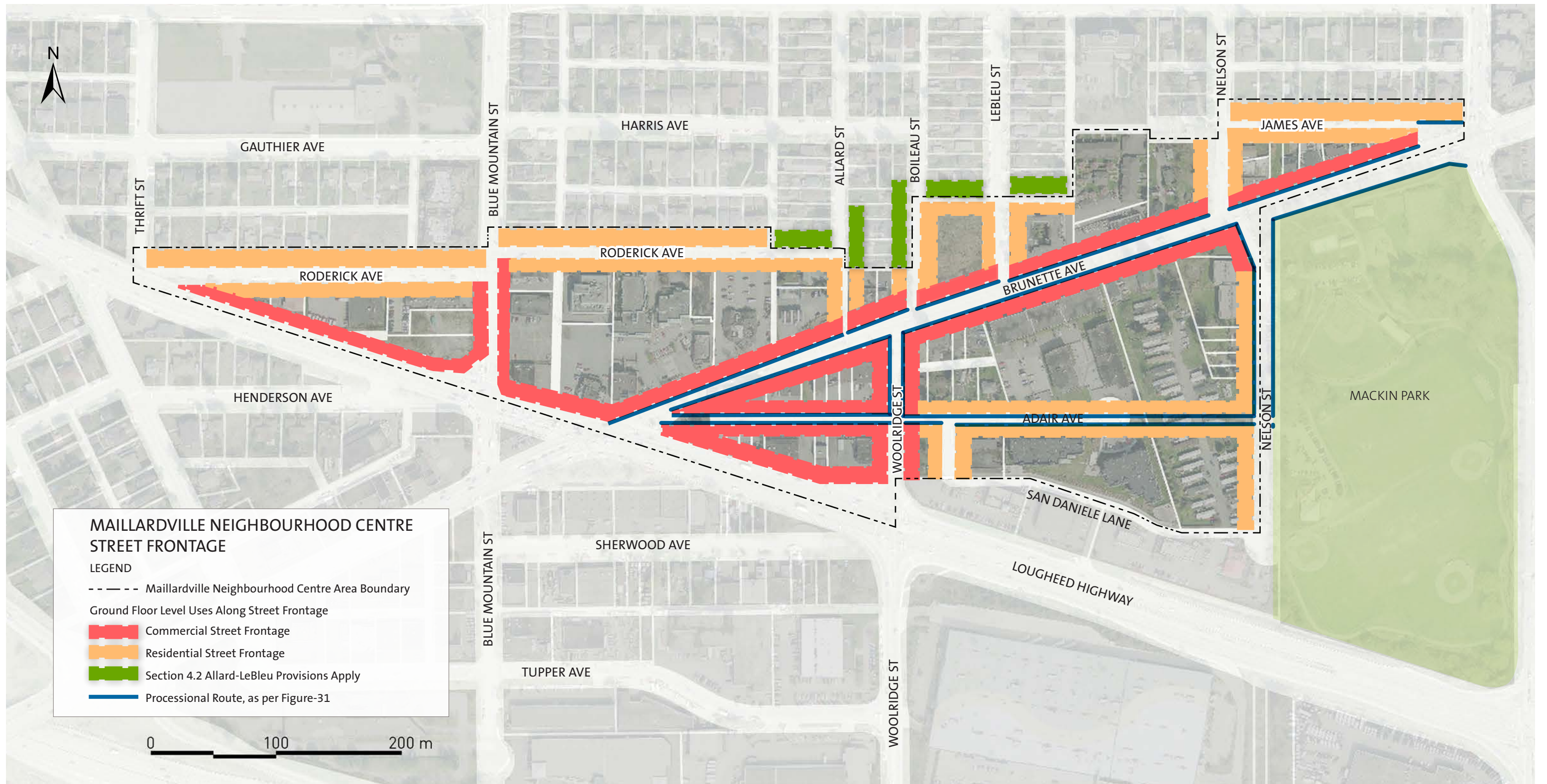

Figure-4 Neighbourhood Centre

This page intentionally left blank

4.1.1 Commercial Frontages

Three Commercial Frontage types – Type ‘A’ (page 16), Type ‘B’ (page 18) and Type ‘C’ (page 19) – are included for flexibility to adapt to local conditions, while retaining design continuity. Requirements for each frontage type are defined through a combination of the guidelines, plan-view and cross-section drawings outlined below. Specifications on the applicable paving materials, lighting, landscaping and site furnishings identified in each ‘type’ are provided in Section 5.0.

Guidelines

Determining Frontage Type

- a. All frontages identified as ‘Commercial’ in Figure-4 will be treated as commercial to ensure design consistency, even if the ground floor level uses along the street are other than commercial uses.
- b. Public on-street parking pockets (Commercial Frontage Type ‘A’) should be used in all locations where sufficient road width exists and other demands, such as transit stops, utility kiosks and related amenities, and priorities of the streetscape and City bylaws can be upheld.
- c. Use Type ‘A’ for all Commercial Street Frontages as identified on Figure 4 Neighbourhood Centre, where feasible. Where Type ‘A’ cannot be achieved due to constraints, or where there is a design benefit, Type ‘B’ and Type ‘C’ should be applied. The applicable frontage type will be determined by the City through the development application and functional design review process. Where Type ‘A’ is not used, the following apply:
 - i. Apply Type ‘B’ at all corners of intersections and driveway let-downs to preserve sight lines for vehicles turning and pedestrian crossings.
 - ii. Integrate Types ‘B’ and ‘C’ in mid-block locations, in alternating segments of consistent length.
 - iii. Seek to match each frontage type with that implemented on the opposite side of the street.
 - iv. Where a block is short the layout should strive to provide equal lengths of Type ‘B’ at the corners and a longer single Type ‘C’ in the middle.
- v. Entire blocks should be conceptually designed by the first development proposal to ensure the overall design intent can be met and prevent atypical blocks of either type from occurring.

All Commercial Frontage Types

- a. Provide enhanced streetscape infrastructure for hanging flower baskets, banners and seasonal lighting receptacles on the street light poles in accordance with Figure-31 of Section 4.4 (page 51) to demarcate the historic ‘processional route.’
- b. Retain and integrate the existing Maillardville archway and unique bus shelter in the current locations.
- c. Patio and outdoor display areas, as illustrated in Commercial Frontage Type ‘B,’ are encouraged for all Commercial Frontage types.
- d. Uses in the Building Frontage Zone could include public seating, outdoor eating associated with restaurants and coffee shops and outside display of merchandise provided that the dimensions of other Zones are maintained and the objectives of the City of Coquitlam’s Encroachment Policy are upheld.
- e. The Building Frontage Zone could be used as a secondary siting area for elements of the streetscape that are usually in the Furnishings Zone.
- f. Ventilation structures, controller and other utility vaults, boxes and kiosks should be located in the Furnishings Zone. Covers, hatches and grates should have a surface texture that is slip-resistant.
- g. Include concrete bands along property lines in hard surface areas.
- h. Locate additional benches at transit stops
- i. Integrate transit shelters in the streetscape where feasible.

Commercial Frontage Type ‘A’

- a. Implement design elements illustrated in Figure-5 and Figure-6, and the Guidelines and specifications in Section 5.0.

Commercial Frontage Type 'A'

Figure 5 'Type A' Plan-View

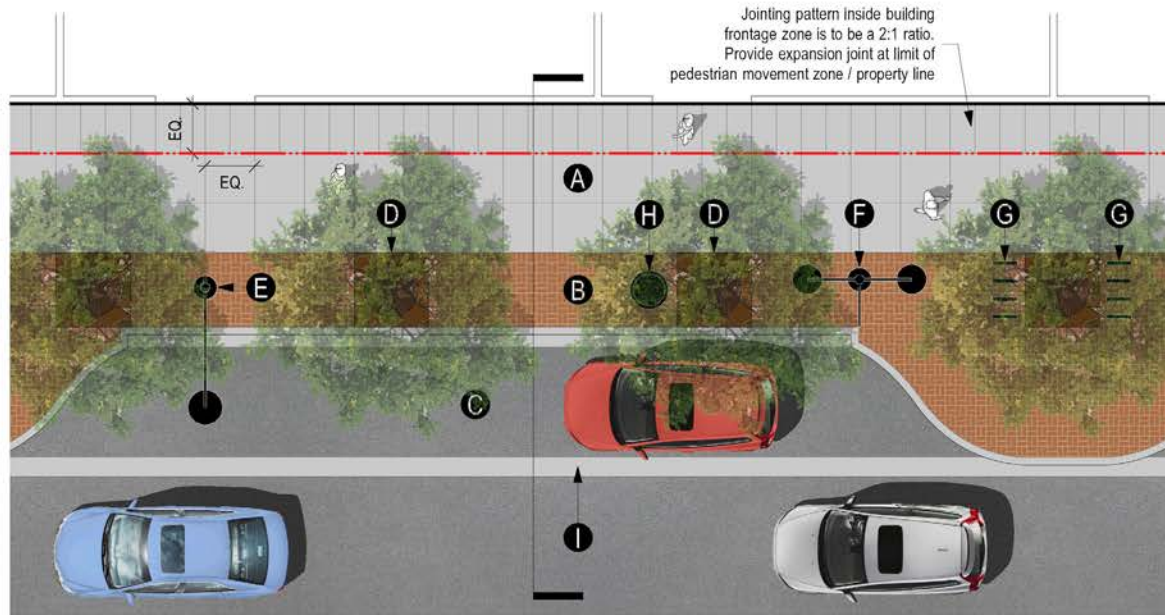

- A** CIP Concrete
- B** CIP Concrete Colored & Stamped
- C** Asphalt
- D** Tree Grate
- E** Street Lighting Type 1 or 2 (depending on reach)
- F** Pedestrian Lighting
- G** Bike Rack Type 1 or 2
- H** Litter Receptacle
- I** Gutter

Figure 6 'Type A' Cross-Section



- b. Include public on-street parking pockets where sufficient road width exists and the design is compatible with other streetscape priorities and City Bylaws.
- c. Separate on-street parking areas from travel lane(s) with a concrete gutter to reduce the perceived width of the street.
- d. Maintain the location of the existing curbs at each end of on-street parking pockets. The retention of existing curbs are encouraged in mid-block locations and at transitions with Type 'B' and 'C' frontages. Wherever feasible, these maintained curb areas could also function as rain gardens and be contiguously designed with adjacent street trees.
- e. Locate site furnishings (i.e. benches, bike racks, etc.) as not to impede pedestrian movement between the parking pocket and the Pedestrian Movement Zone.
- f. Street trees in the Furnishing Zone, adjacent to public parking pockets, should include sufficient growing medium per City bylaw requirements either in the form of structural soil or silva cells.

Commercial Frontage Type 'B'

Commercial Frontage Type 'B' includes the same elements and dimensions as Type 'A' but without on-street parking.

- a. Implement design elements illustrated in Figure-7 and Figure-8, and the specifications in Section 5.0.

Commercial Frontage Type 'C'

Frontage Type 'C' focuses on the integration of seating areas along the Pedestrian Movement Zone, protected from vehicle traffic. The seating areas are envisioned for mid-block locations without on-street parking. Raised planters equal to the width of the Furnishings Zone, with low plantings, are located in this zone.

- a. Implement design elements illustrated in Figure-9 and Figure-10, and the specifications in Section 5.0.

- b. Integrate indents within the furnishing zone planter to create enclosed seating pockets. Two benches should be provided in each seating pocket. Provide additional space adjacent to the paired benches to accommodate wheelchairs and scooters.
- c. Design paving in front of bench areas with a 2:1 ratio, with the long side perpendicular to the direction of pedestrian travel. Paving for all other areas of the Pedestrian Movement Zone remains consistent with the simple square jointing pattern of Frontage Types 'A' and 'B'.
- d. Align jointing patterns with the outside edges of the planters and the seating pockets.



Image-8 Demonstrates Seating and Outdoor Display



Image-9 Demonstrates Site Furnishing Zone

Commercial Frontage Type 'B'

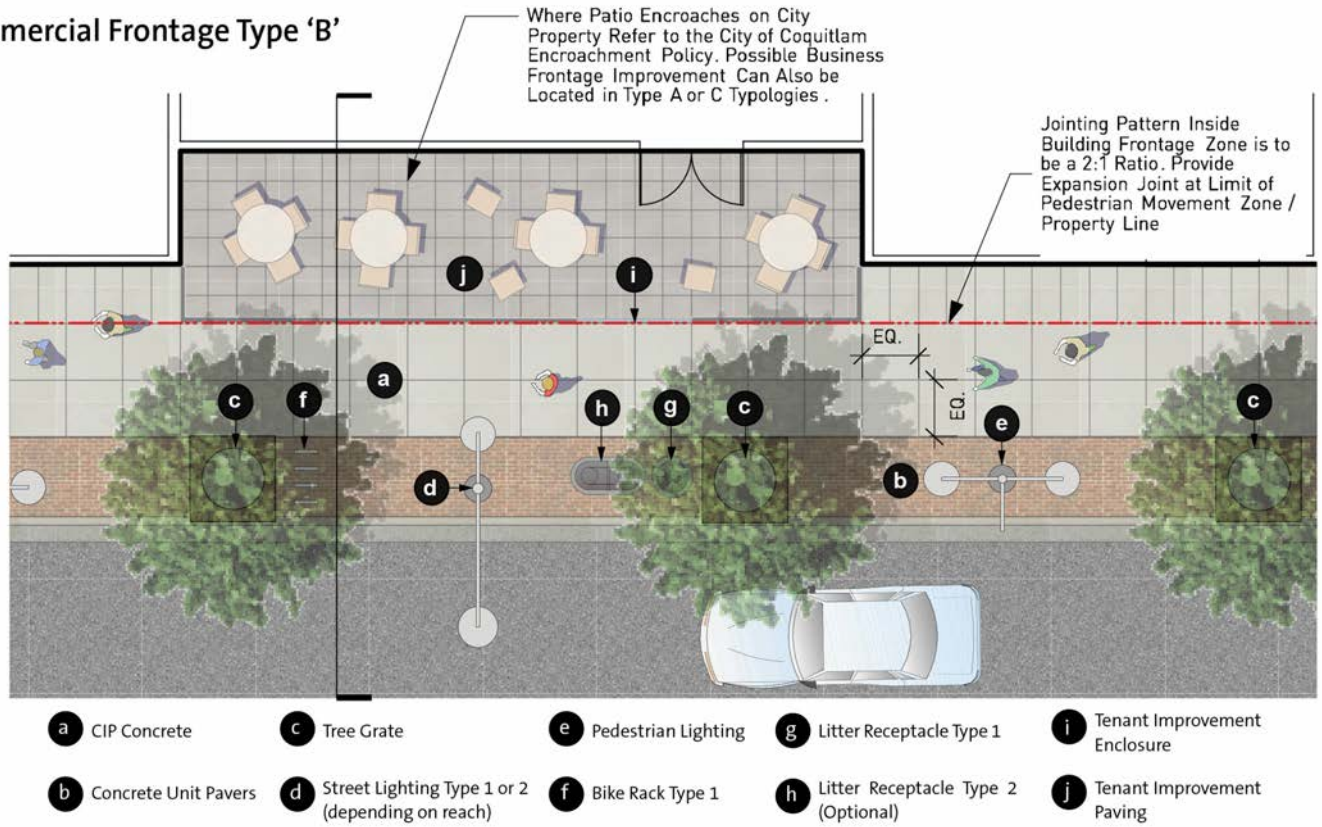
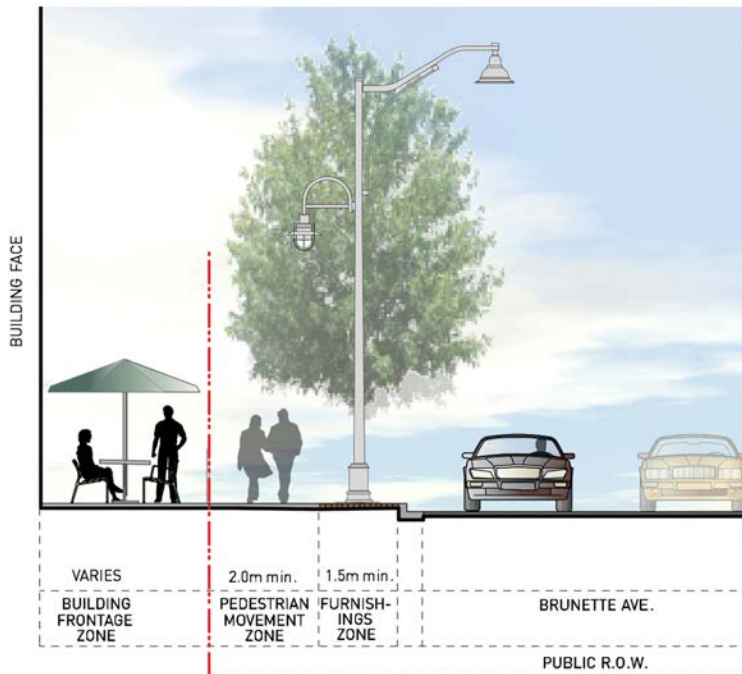

Figure-7 Type 'B' Plan-View



Note: Pedestrian Movement
Patio encroachments into
not permitted unless a width
provided.

Figure-8 Type 'B' Cross-Section

Commercial Frontage Type 'C'

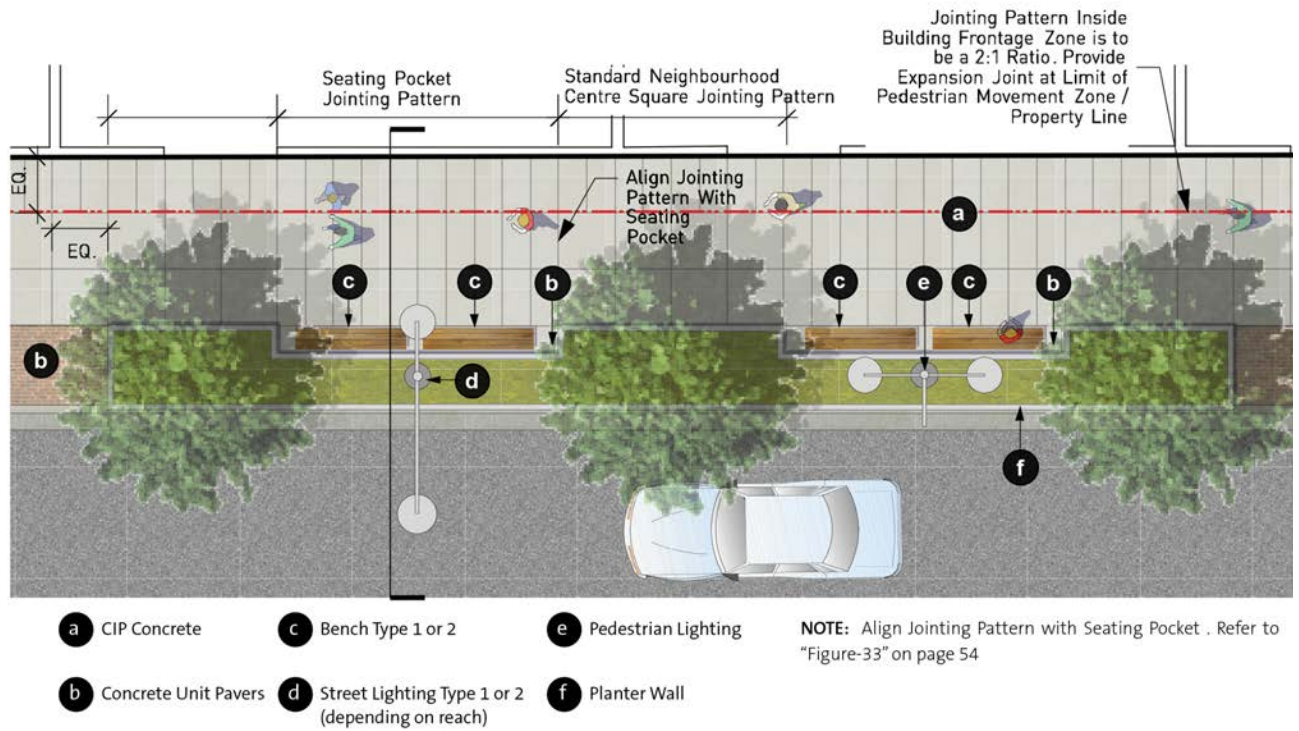

Figure-9 Type 'C' Plan-View

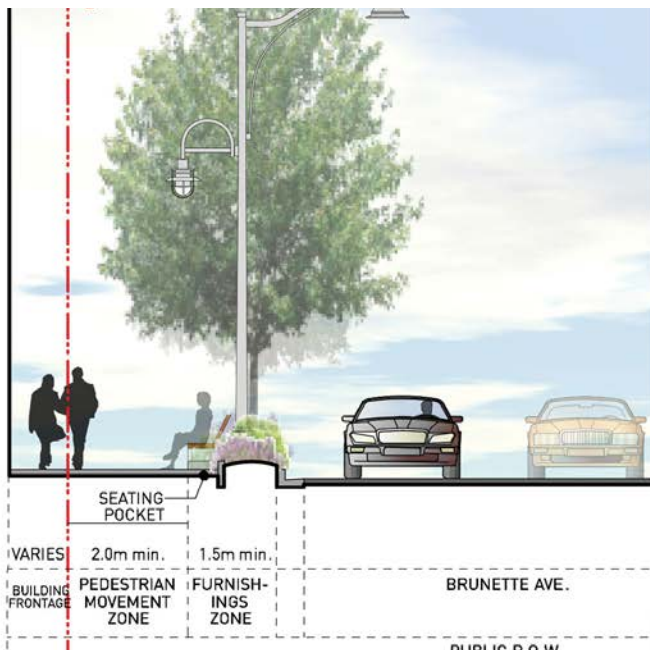

Figure-10 Type 'C' Cross-Section

4.1.2 Residential Frontage: Local Road - Higher Density*

Streetscapes fronting 'Higher-Density Residential' (i.e. apartments) in the Neighbourhood Centre should reflect an urban character to maintain continuity with nearby commercial areas and provide a transition to lower density areas further from the core. A Furnishings Zone similar to the commercial area will support increased pedestrian volumes and improve access to on-street parking.

Guidelines

- a. Implement design elements illustrated in Figure-11 and Figure-12, and the specifications in Section 5.0.
- b. Generally apply the streetscape guidelines to both sides of the street to ensure continuity. This includes frontages outside the Character Area (see Figure-4: page 13).
- c. Plant a second row of canopy trees located within the Development Front/Side Yard area to establish a framed pedestrian corridor along the sidewalk. This second row of trees should be staggered in relation to the street trees in the Furnishing Zone.
- d. Integrate enhanced landscape areas in the streetscape, including curb extensions, that are coordinated with the main entrances of multi-family buildings. Design should include planting within the boulevard and a direct paved connection to the street edge.



Image-10 Demonstrates Residential Frontage Double Row of Trees

* As coordinated with the DRAFT City of Coquitlam Multi-Modal Street Design Standards, 2013

Residential Frontage: Local Road - Higher Density

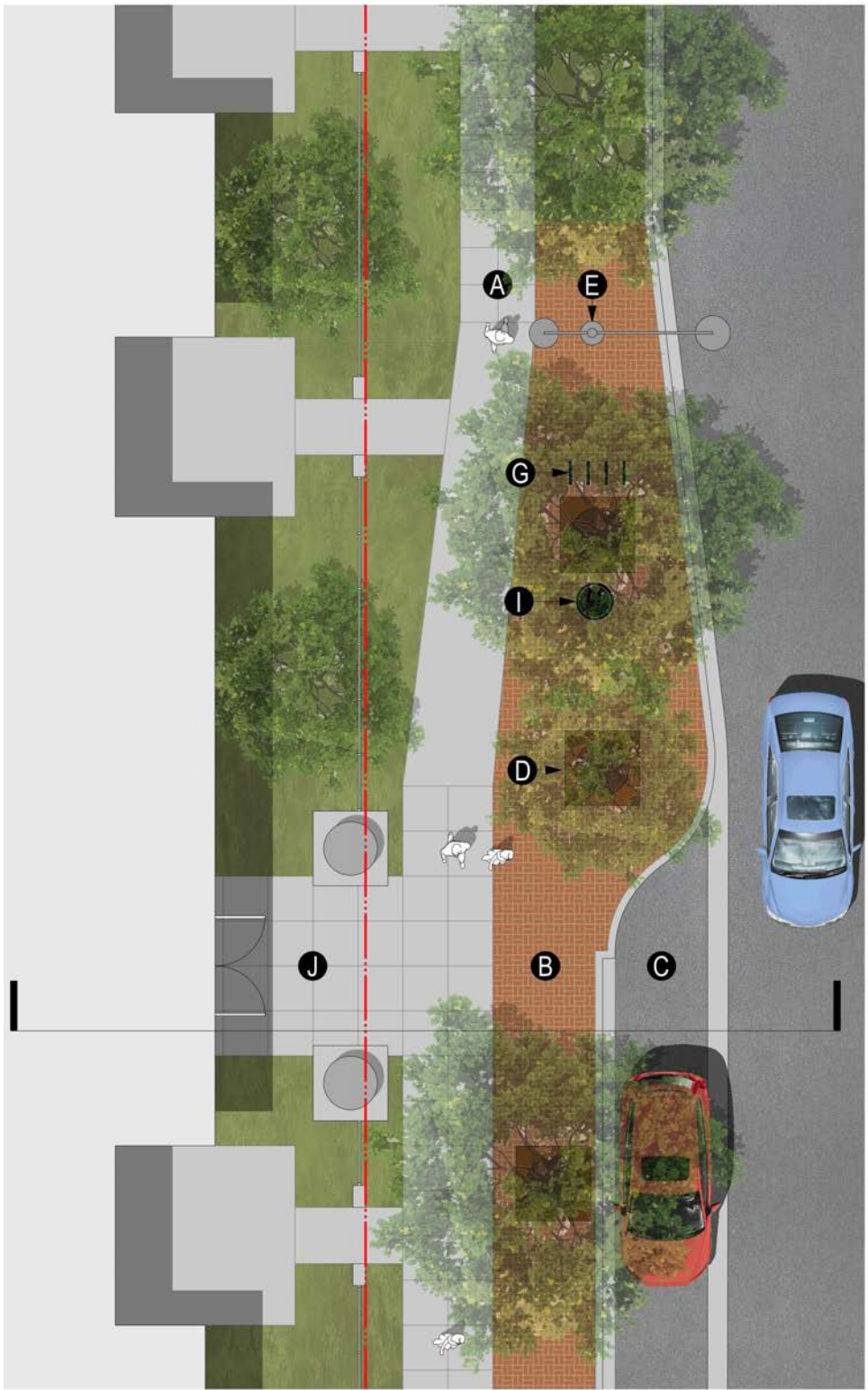

- A** CIP Concrete
- B** CIP Concrete Colored and Stamped
- C** Asphalt
- D** Tree Grate
- E** Street Lighting Type 1 or 2 (depending on reach)
- F** Bench Type 1 or 2
- G** Bike Rack Type 1
- H** Bike Rack Type 2
- I** Litter Receptacle Type 1
- J** Optional: CIP Concrete to bring development front door to curb edge

Figure-11 Local Road - Higher Density, Plan-View

Residential Frontage: Local Road - Higher Density

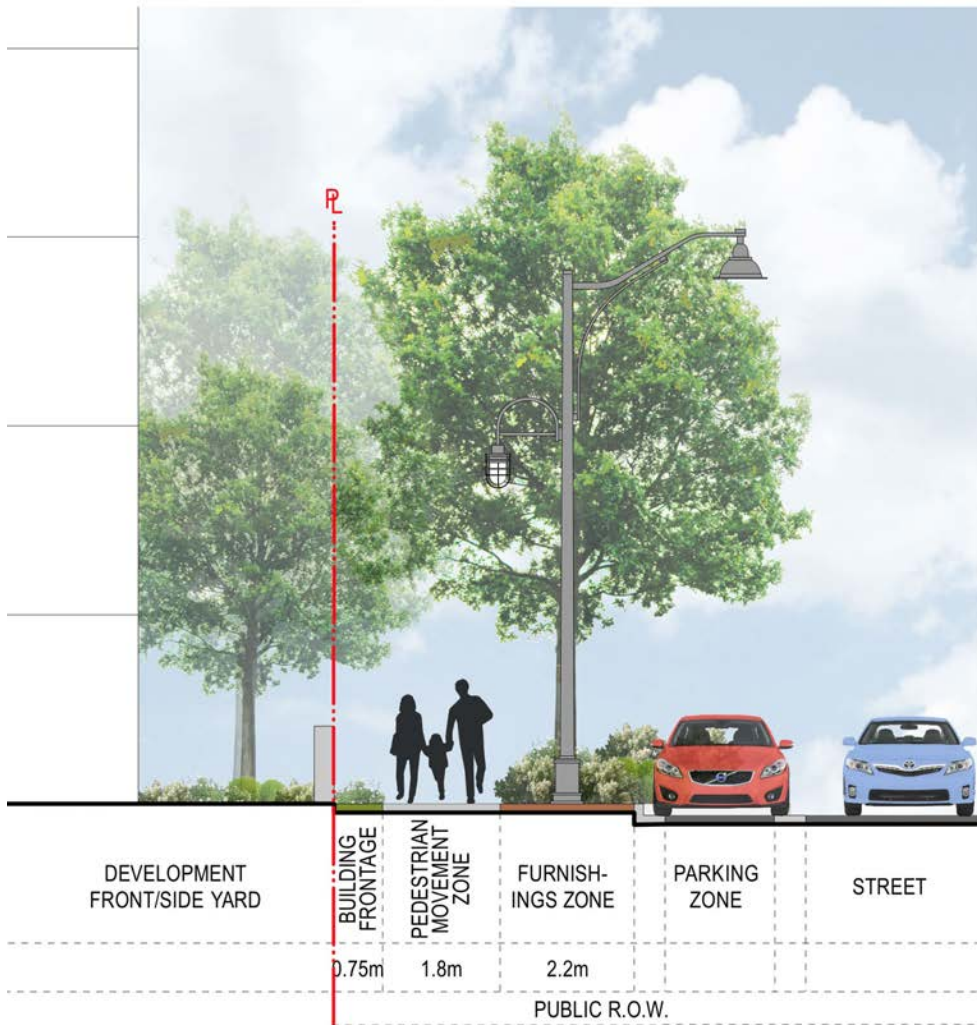

Figure-12 Local Road - Higher Density, Cross-Section

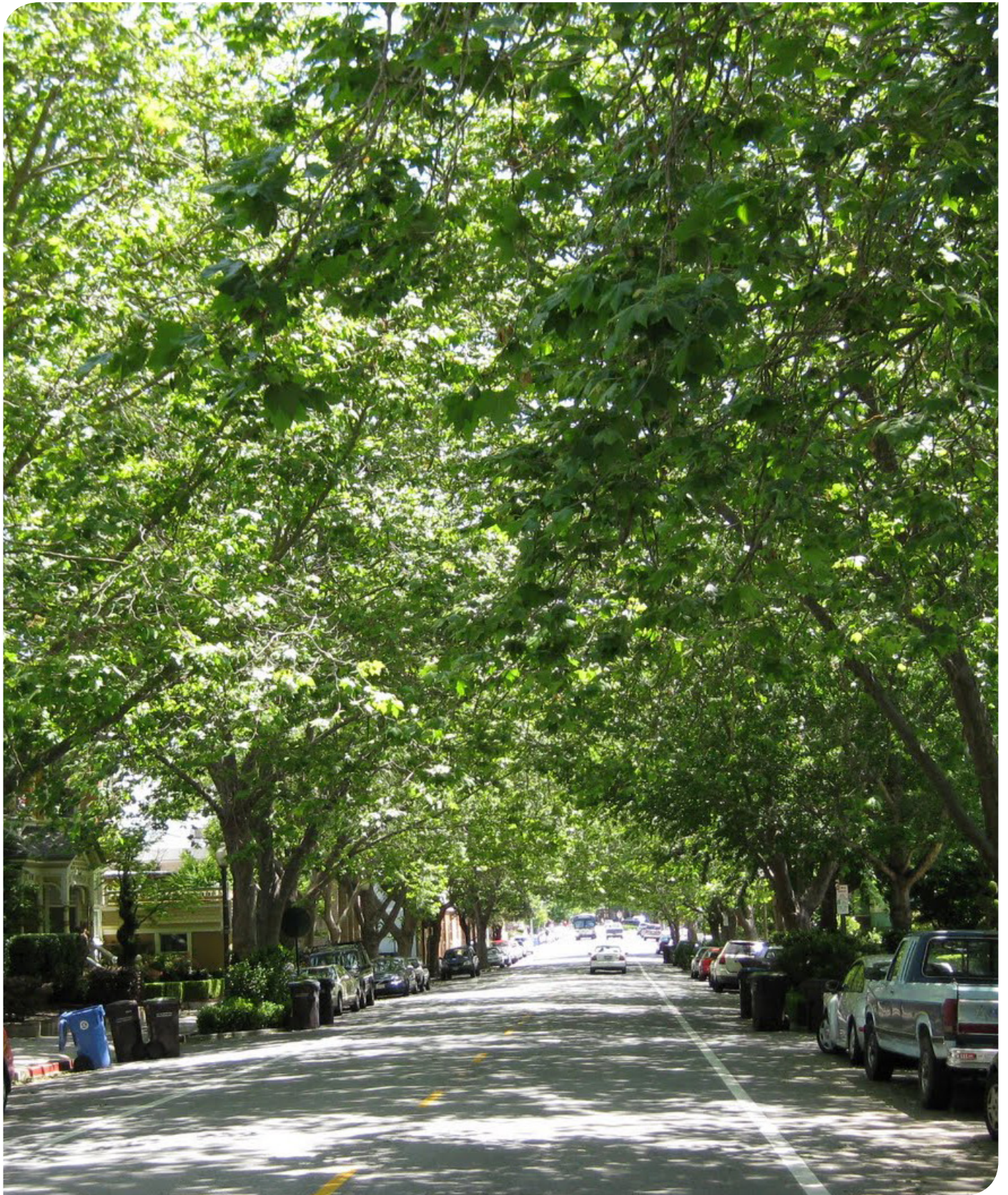

Image-11 Residential Frontage with Prominent Street Tree Planting

4.1.3 Residential Frontage: Local Road - Low Density*

The dimensions identified for this streetscape correspond with standards set out in the City of Coquitlam Subdivision and Development Servicing Bylaw (Multi-Modal Street Design Standards).

Streetscapes fronting Medium to lower density residential development (i.e. low-rise apartment, townhousing, Housing Choices) in the Neighbourhood Centre should strive to maintain an understated urban character. This will be achieved through the use of Neighbourhood Centre-specific elements and paving. Reduced pedestrian demands allow for a decrease in hard surface materials and a transition to a more traditional residential boulevard treatment with soft landscaping, such as turf grass and plantings.

Guidelines

- a. Implement design elements illustrated in Figure-13 and Figure-14, and the specifications in Section 5.0.
- b. Generally apply the streetscape guidelines to both sides of the street to ensure continuity. This includes frontages outside the Character Area (see Figure-4: page 13).
- c. Boulevards should primarily be planted with turf grass, however, the City will consider plantings in accordance with the species list provided in Section 5.3. Where plantings are proposed, an agreement will be required to designate maintenance and irrigation responsibilities to the fronting Strata Corporation/Owner, as appropriate.
- d. Plant a second row of trees on the development parcel to create an 'allée' (a tree-framed pedestrian corridor) along the sidewalk. These trees are to be the same species as the boulevard street trees.



Image-12 Residential Frontage: Pedestrian Movement Zone and Boulevard



Image-13 Residential Frontage Planted Boulevard Zone

* As coordinated with the DRAFT City of Coquitlam Multi-Modal Street Design Standards, 2013

Residential Frontage: Local Road - Low Density

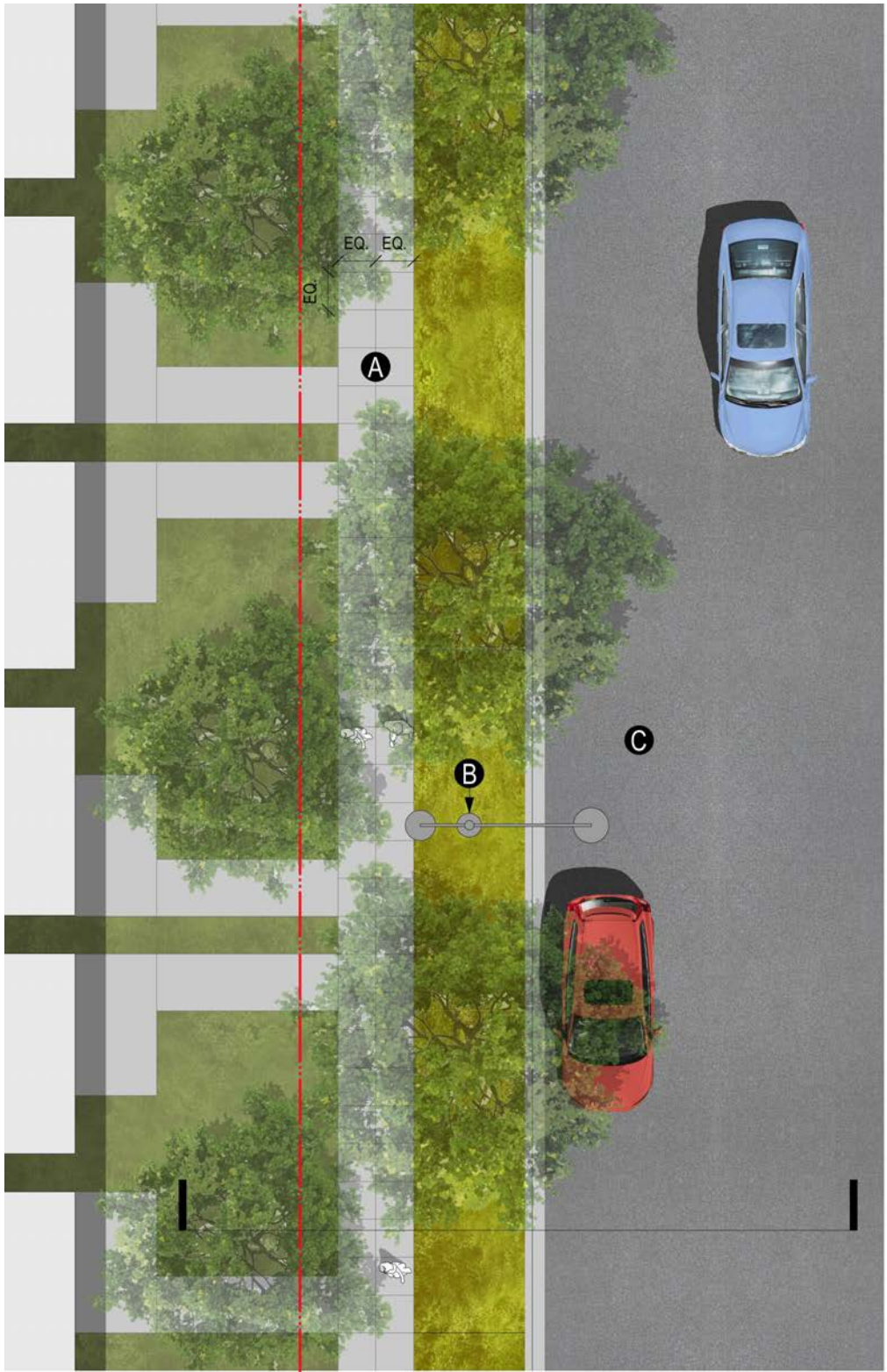

- A** CIP Concrete
- B** Street Lighting Type 1 or 2 (depending on reach)
- C** Asphalt

Figure-13 Plan-View: Residential Frontage - Low Density

Residential Frontage: Local Road - Low Density

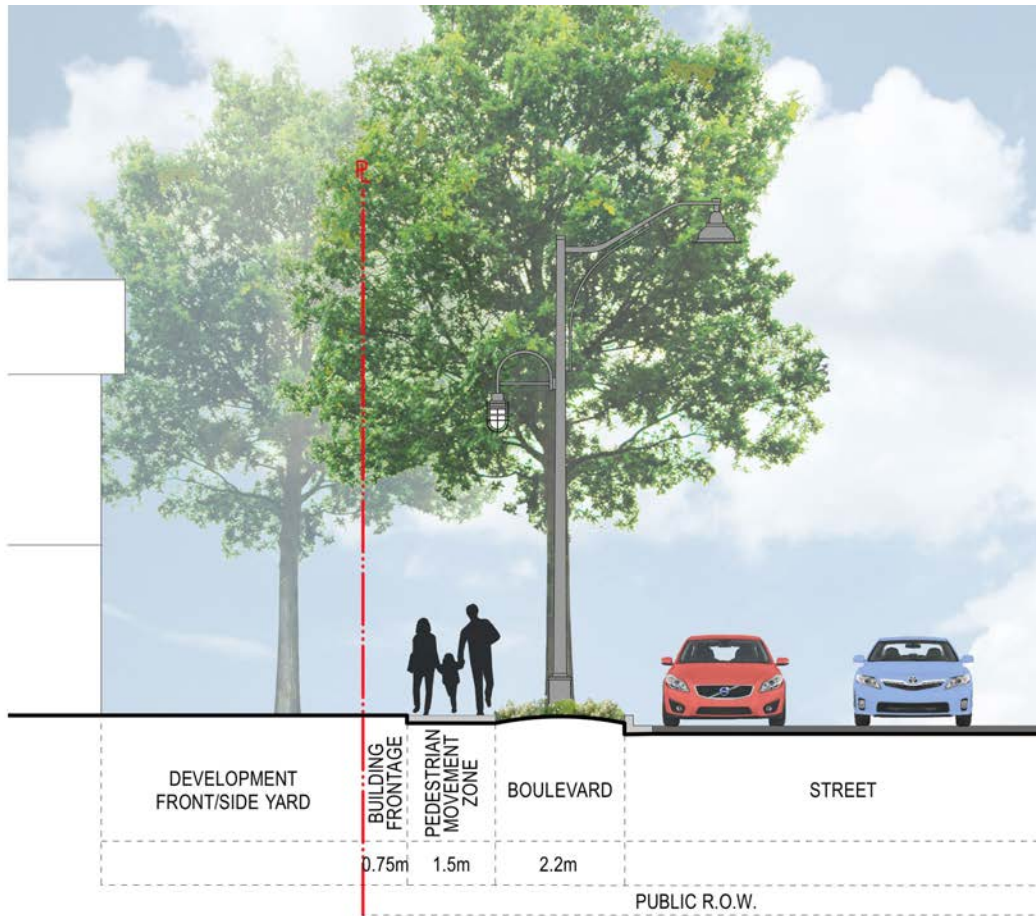

Figure-14 Cross-Section: Residential Frontage - Low Density



Image-14 Demonstrates Commercial Frontage Site Furnishing Zone Planting and Seating

4.2 Heritage Character Areas: Laval Square and Allard-LeBleu

Laval Square and Allard-LeBleu are original 'town-site' areas that are particularly unique and important heritage precincts. The Laval Square Heritage Character Area, the eastern terminus for the historic 'processional route', will have increased residential densities, which will result in higher demands on the streetscape corridor. (see Figure 15) Streetscape improvements reference a heritage-inspired context by blending a traditional town centre church square with a residential setting, through the use of character lighting and street tree and boulevard plantings.

The Allard-LeBleu Heritage Character Area is also a distinct residential area within Maillardville that will be a low-density heritage enclave adjacent to the higher-density Neighbourhood Centre (see Figure 16). This character area should be developed to have visual connectedness as well as strong pedestrian connections with the Centre in order to maximize the walkability of the neighbourhood and promote use of the local businesses by residents. A traditional residential character should be provided with tree lined streets.

As illustrated in Figure-24 Greenways & Parkettes (page 41), a Citywide Greenway bisects these heritage character areas. Design requirements identified for the Laval Square and Allard-LeBlue Heritage Character Areas and the historic 'processional route' will need to be coordinated and integrated with the future implementation of the Citywide Greenway.

Design Intent:

- Develop unique residential character areas within the broader context of Maillardville and the City.
- Infuse the area with heritage inspired elements to recognize the historical cultural values of the neighbourhood.
- Develop a streetscape corridor that provides a safe and comfortable walking routes.
- Provide clear connections to Brunette Avenue for pedestrians and cyclists to reinforce community-wide connections.
- Extend elements of the Neighbourhood Centre into these residential neighbourhoods to create visual and physical connections between these areas.
- Create a grand loop for the east terminus of the historical 'processional route' that is coordinated with the Greenway route.



Image-15 Notre Dame de Lourdes, Laval Square

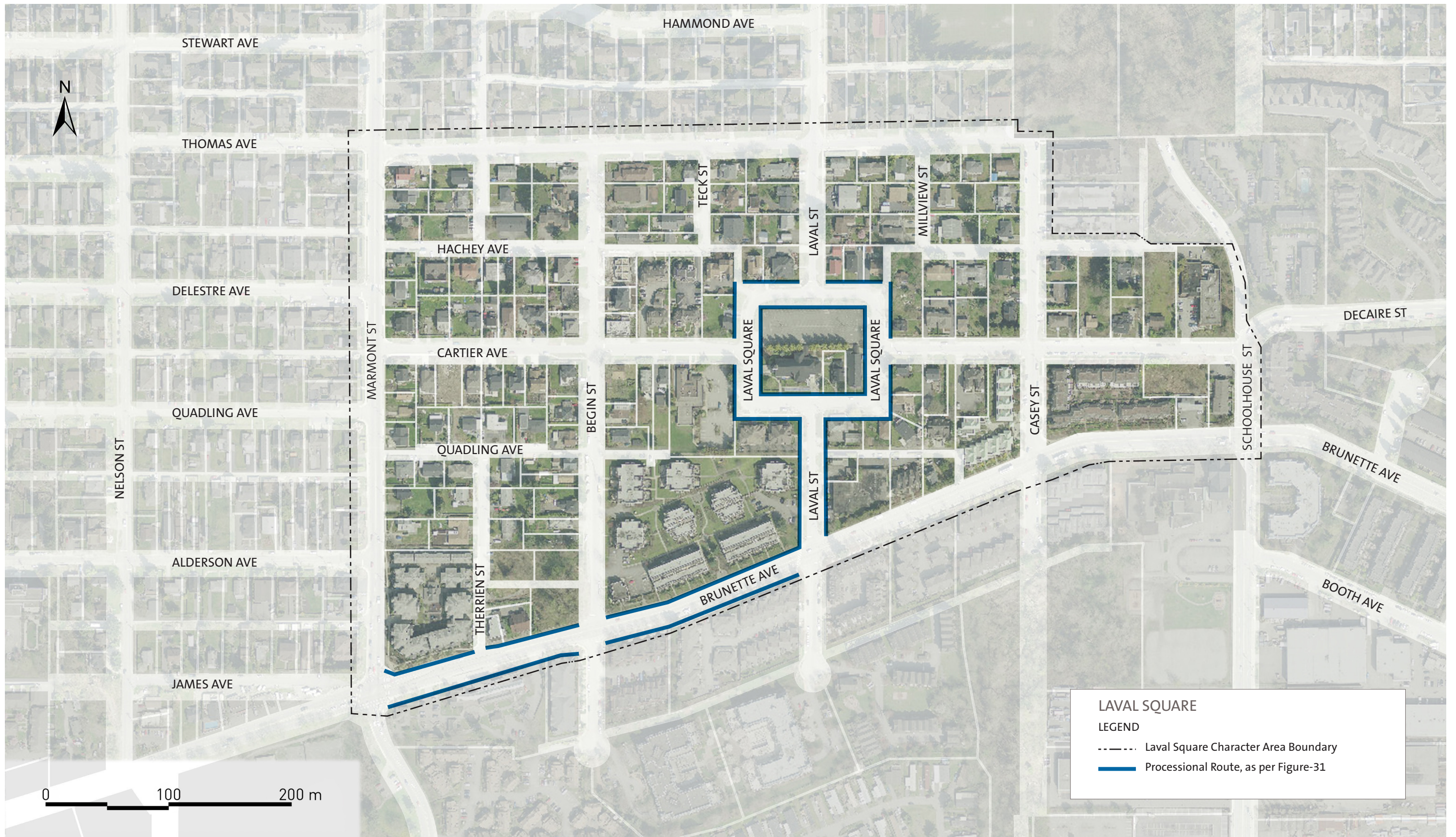

Figure-15 Laval Square Heritage Character Area

This page intentionally left blank

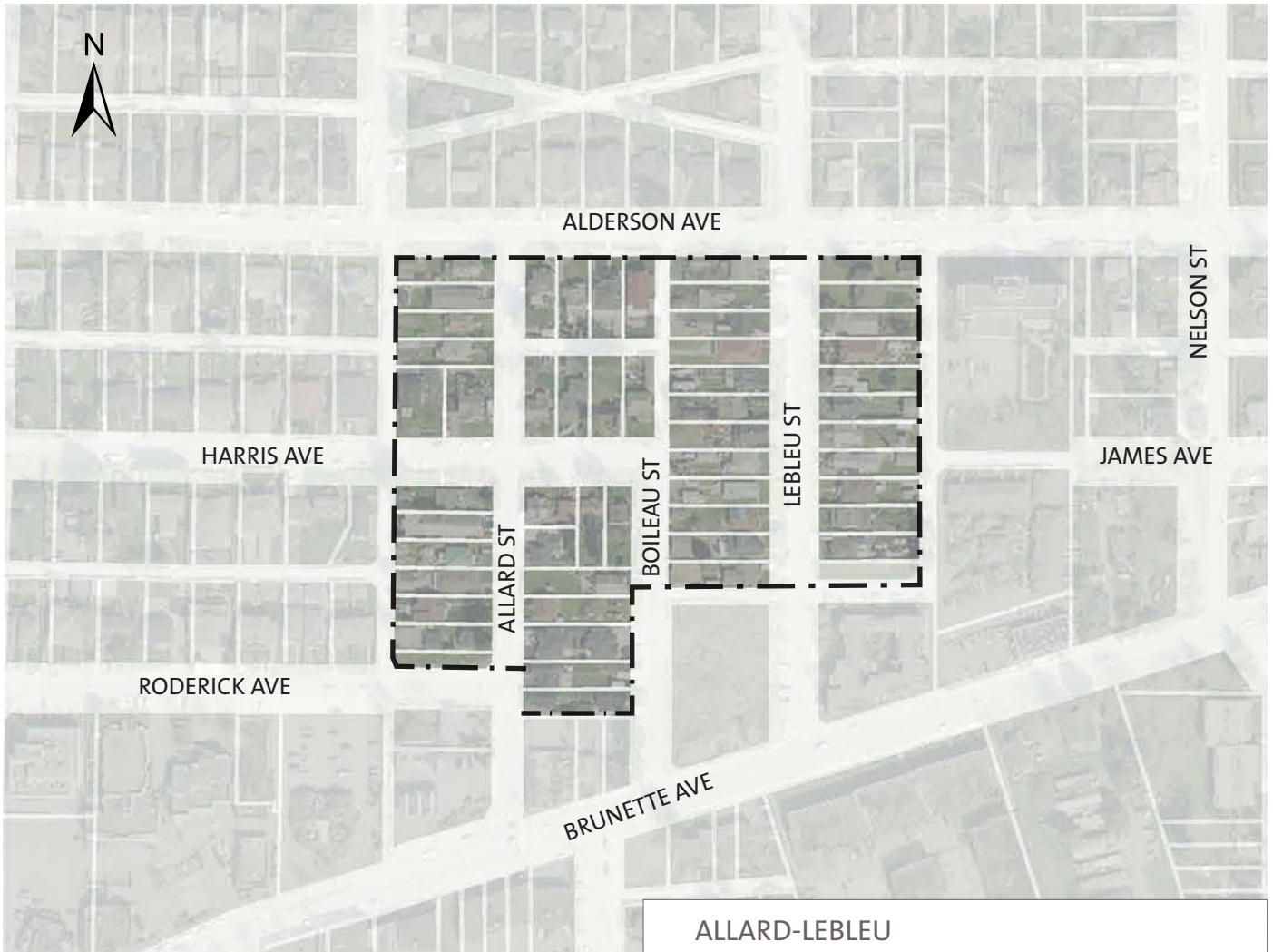

Figure-16 Allard-LeBleu Heritage Character Area

ALLARD-LEBLEU
LEGEND
 - - - Allard-LeBleu Character Area Boundary

4.2.1 Laval Square

Laval Square is the geographic and historical centre of the Laval Square Heritage Character area (see Figure 17). The church property in the middle of the square is a landmark within Maillardville and a unique cultural tie to the history of the neighbourhood and the City. Streetscape improvements are focused on the outer ring of the road right-of-way to enhance the pedestrian experience and frame the church property.

Guidelines

- a. Implement design elements illustrated in Figure-18 and Figure-19, and the specifications in Section 5.0.
- b. Provide enhanced streetscape infrastructure for hanging flower baskets, banners and seasonal lighting on the light poles in accordance with Figure-31 of Section 4.4 to demarcate the historical 'procession route.'
 - i. Locate receptacles for seasonal lighting on light poles fronting the interior of Laval Square.
 - ii. Locate infrastructure for banners and hanging baskets on the exterior frontages of Laval Square at the back of sidewalk.
- c. Provide increased sidewalk width beyond the minimum standard along exterior frontages of Laval Square where the width of the right of way can accommodate it.
- d. All boulevards are to be landscaped with plantings specified in Section 5.4. Particular emphasis should be placed on integrating lavender as a prominent character element on all frontages.



Image-16 Lavender Planting



Image-17 Lavender Planting in Boulevard



Figure-17 Key Plan - Frontages on Laval Square



- a** CIP Concrete
- b** Street Lighting Type 1 or 2 (depending on reach)
- c** Street Lighting Type 1 or 2; No Pedestrian Light (depending on reach)

Figure-18 Plan - Frontages on Laval Square

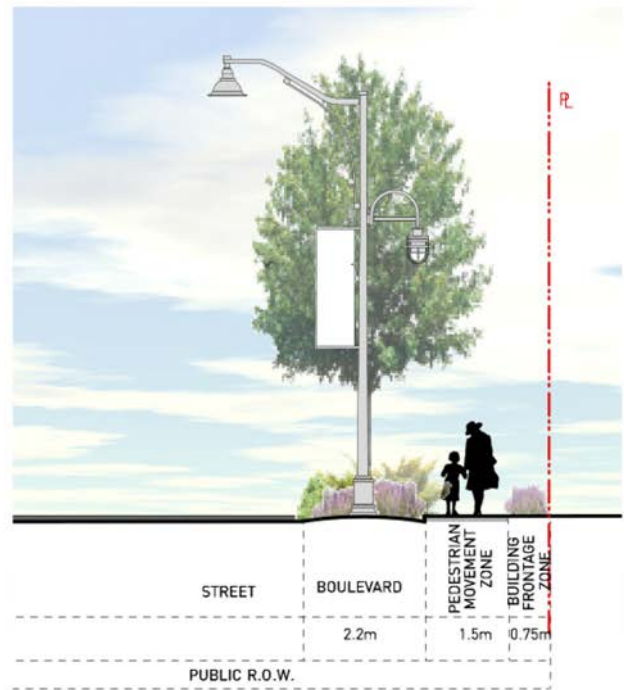
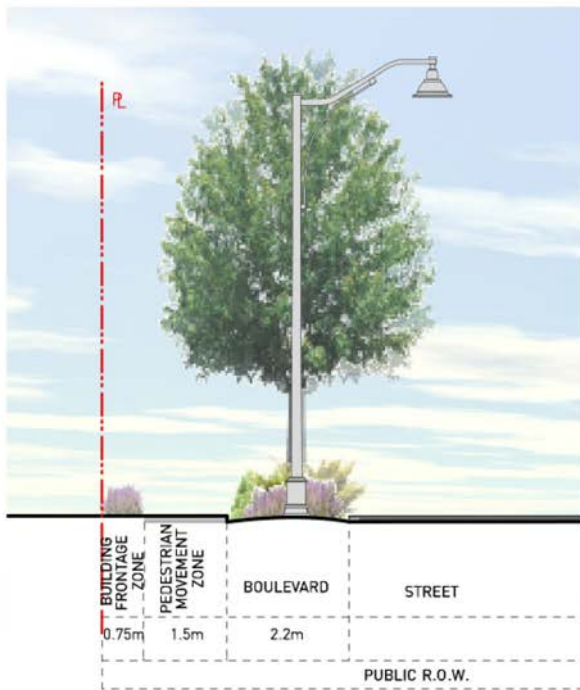

Figure-19 Section - Frontages on Laval Square

4.2.2 City Arterial Street* - Residential Frontage (Brunette Ave. and Marmont St.)

Residential streetscapes on 'City Arterial Streets' in the Laval Square Character Area should reflect an urban character to maintain continuity with nearby commercial areas and provide a transition to lower density areas further from the core. A 'boulevard zone' with grass will reflect a transition away from the higher pedestrian area of the Neighbourhood Centre.

Guidelines

- a. Implement design elements illustrated in Figure-20 and Figure-21, and the specifications in Section 5.0.
- b. Apply the streetscape guidelines to both sides of the street to ensure continuity. This includes frontages outside the Heritage Character Area.
- c. Plant a second row of canopy trees on the development parcel to create a framed pedestrian corridor along the sidewalk.
- d. Provide enhanced streetscape infrastructure for hanging flower baskets, banners and seasonal lighting on the light poles, in accordance with Figure-31 (page 51) of Section 4.4, to demarcate the historic 'processional route' along Brunette Avenue.



Image-18 Enclosed and Comfortable Pedestrian Realm

* As coordinated with the DRAFT City of Coquitlam Multi-Modal Street Design Standards, 2013

City Arterial Street* - Residential Frontage (Brunette Avenue and Marmont Street)

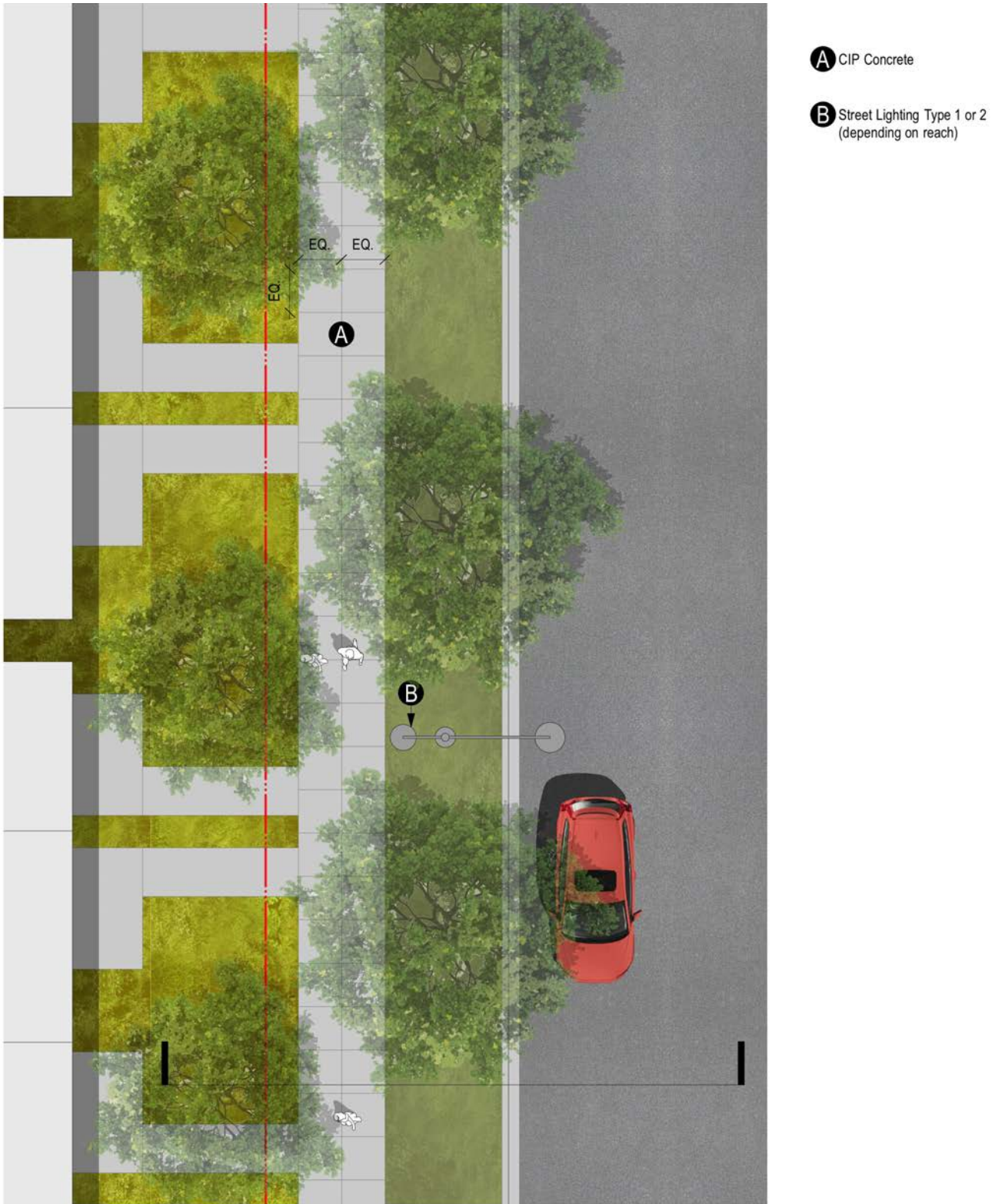
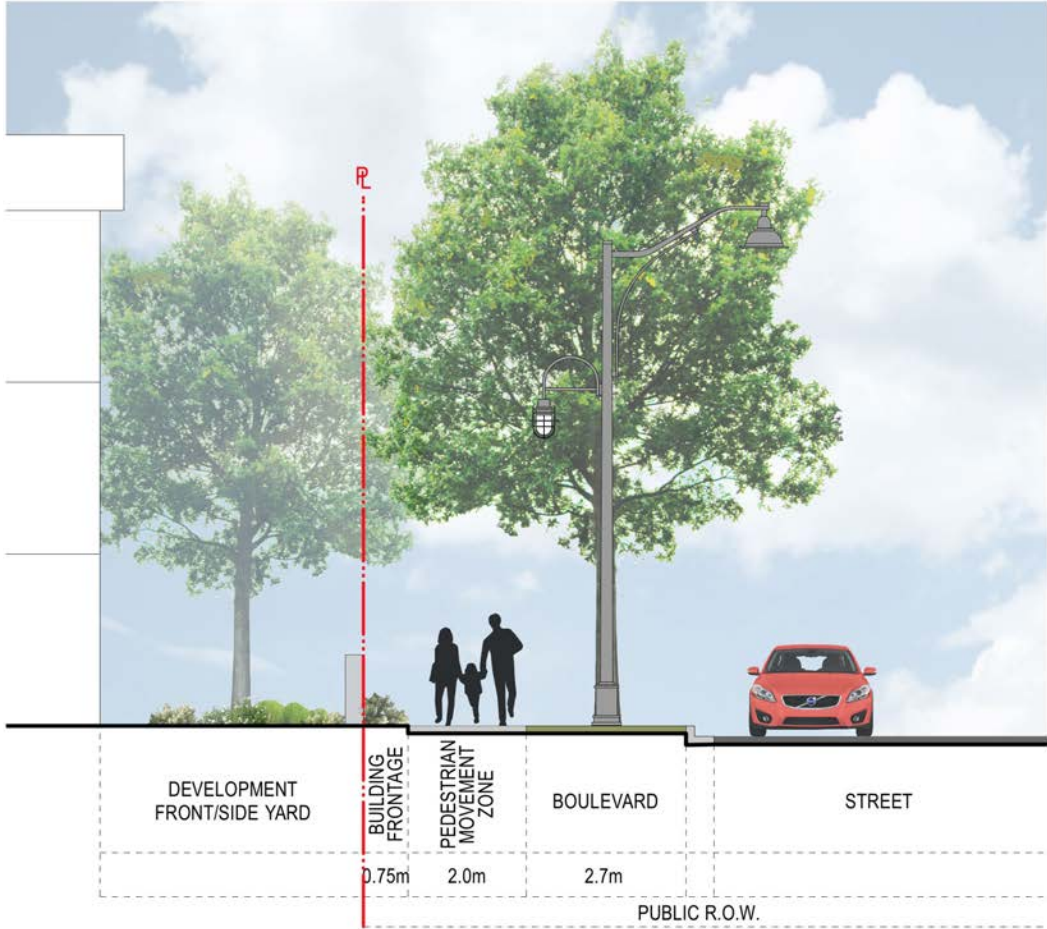

Figure-20 City Arterial Street - Residential Frontage, Plan-View

City Arterial Street - Residential Frontage (Brunette Avenue and Marmont Street)



4.2.3 Local Residential Street

'Lower-density local streets' comprise all of the Allard-Lebleu Heritage Character Area streets and the majority of the Laval Square Character area streets with the exception of Laval Square, and those designated as arterial streets. The improvements to these streetscape corridors include the construction of curbs, treed boulevards, new character lighting and sidewalks.

Guidelines

- a. Implement design elements illustrated in Figure-22 and Figure-23, and the specifications in Section 5.0.
- b. Boulevards should primarily be planted with turf grass, however, the City will consider plantings in accordance with the species list provided in Section 4.0. Where plantings are proposed, an agreement will be required to designate maintenance and irrigation responsibilities to the fronting Strata Corporation/Owner.
- c. Provide enhanced streetscape infrastructure for hanging flower baskets, banners and seasonal lighting on the light poles in accordance with Figure-31 (page 51) of Section 4.4 to demarcate the historic 'processional route' along the south leg of Laval Street, connecting Laval Square and Brunette Avenue.

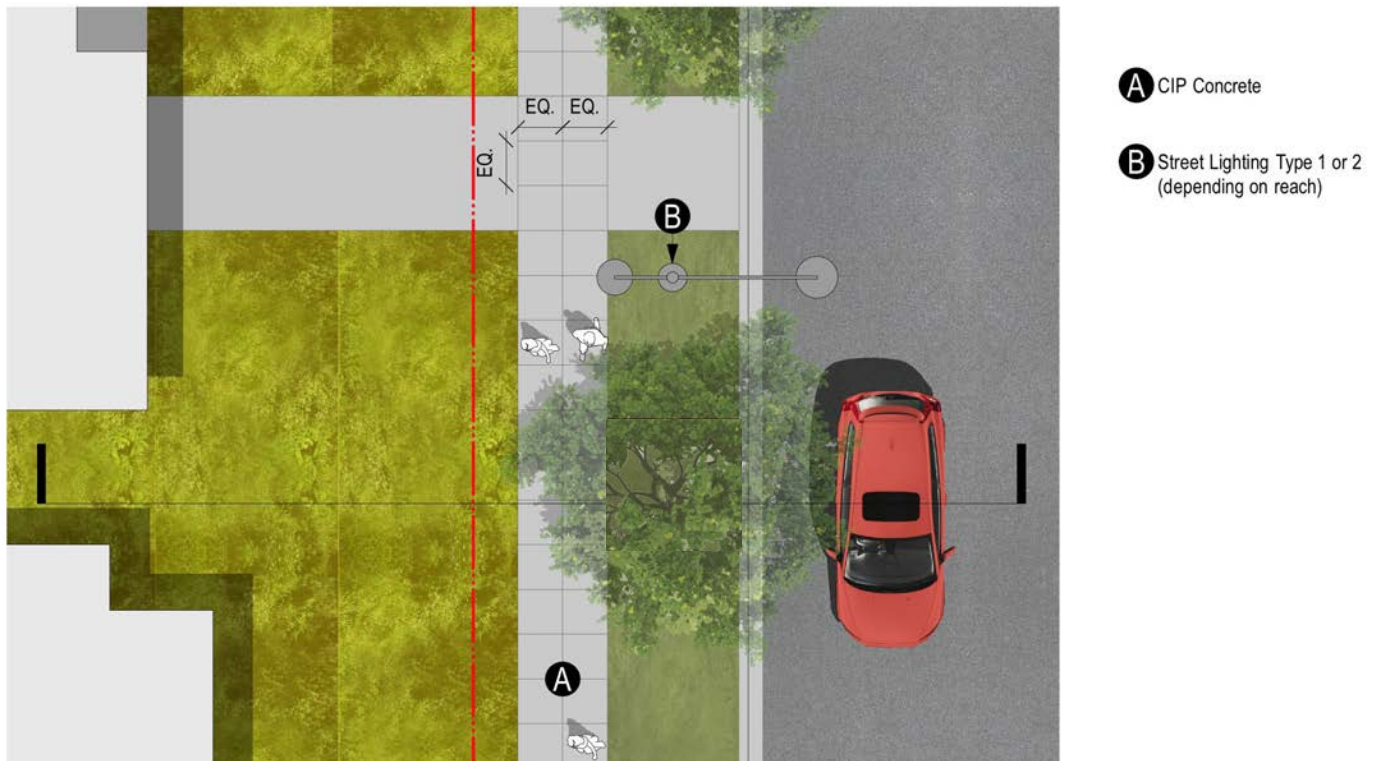

Figure-22 Plan View: Laval Square and Allard-Lebleu Heritage Character Areas - Local Residential Street

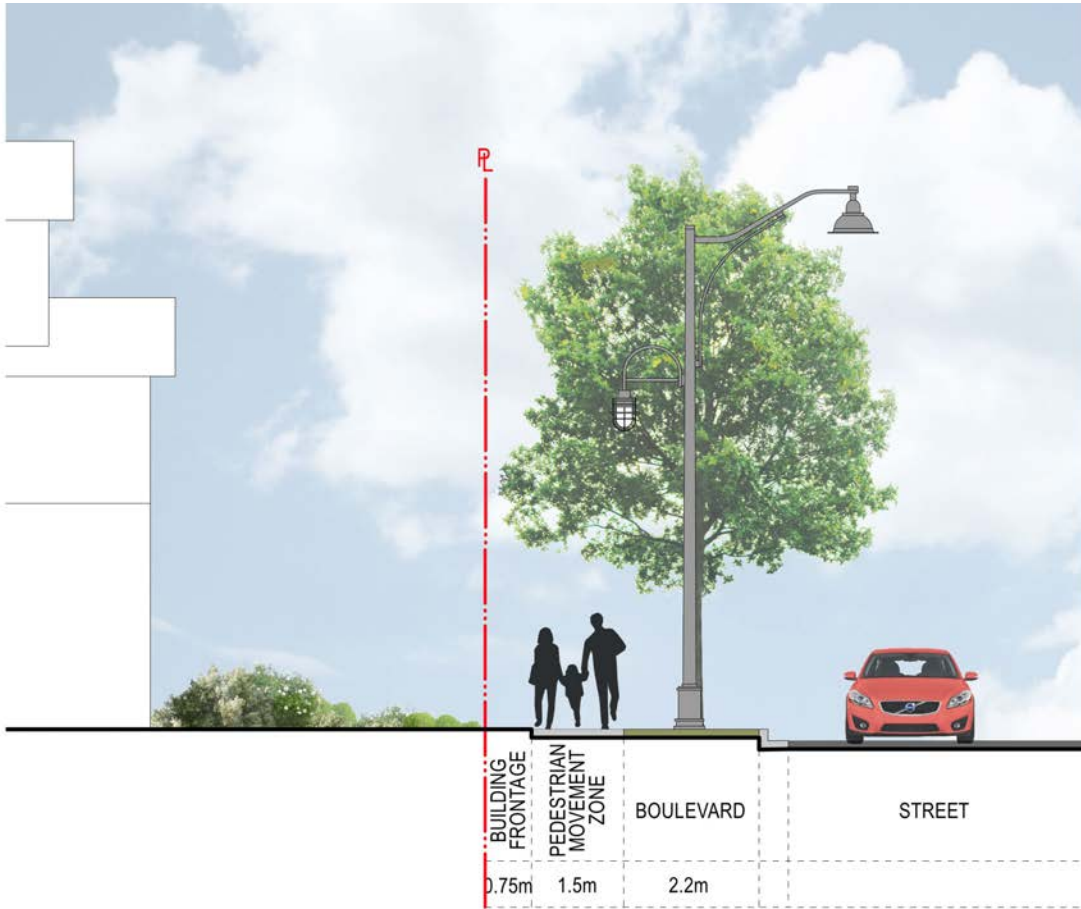

Figure-23 Section: Laval Square and Allard-LeBleu Heritage Character Areas - Local Residential Street

4.3 Greenways

Greenways in Maillardville are intended to reinforce alternate modes of transportation with identifiable routes that reflect a unique Maillardville character.

There are two types of Greenways in Maillardville; (1) Citywide and (2) Neighbourhood specific. This section outlines design expectations for the Neighbourhood (non-Citywide) Greenways identified on Figure-24.

Where Citywide Greenways traverse through Maillardville's distinct 'Character Areas,' the guidelines of the character area take precedence and will be reflected in future design and functional planning. Examples of areas with higher design requirements, as per Character Area provisions, include Laval Square and frontages along the historic 'processional route.'

Design intent:

- Develop a clear visual cue to identify Greenways as a multi-modal route within the neighbourhood.
- Establish a uniform treatment of Greenway surfacing and layout to reinforce the use and character.
- Integrate parkettes at regularly spaced intervals to provide rest areas at the top of hills to support a diversity of ages and abilities.
- Create parkettes with layouts and key elements reflective of Maillardville's history.



Image-19 Greenway Multi-modal Transportation

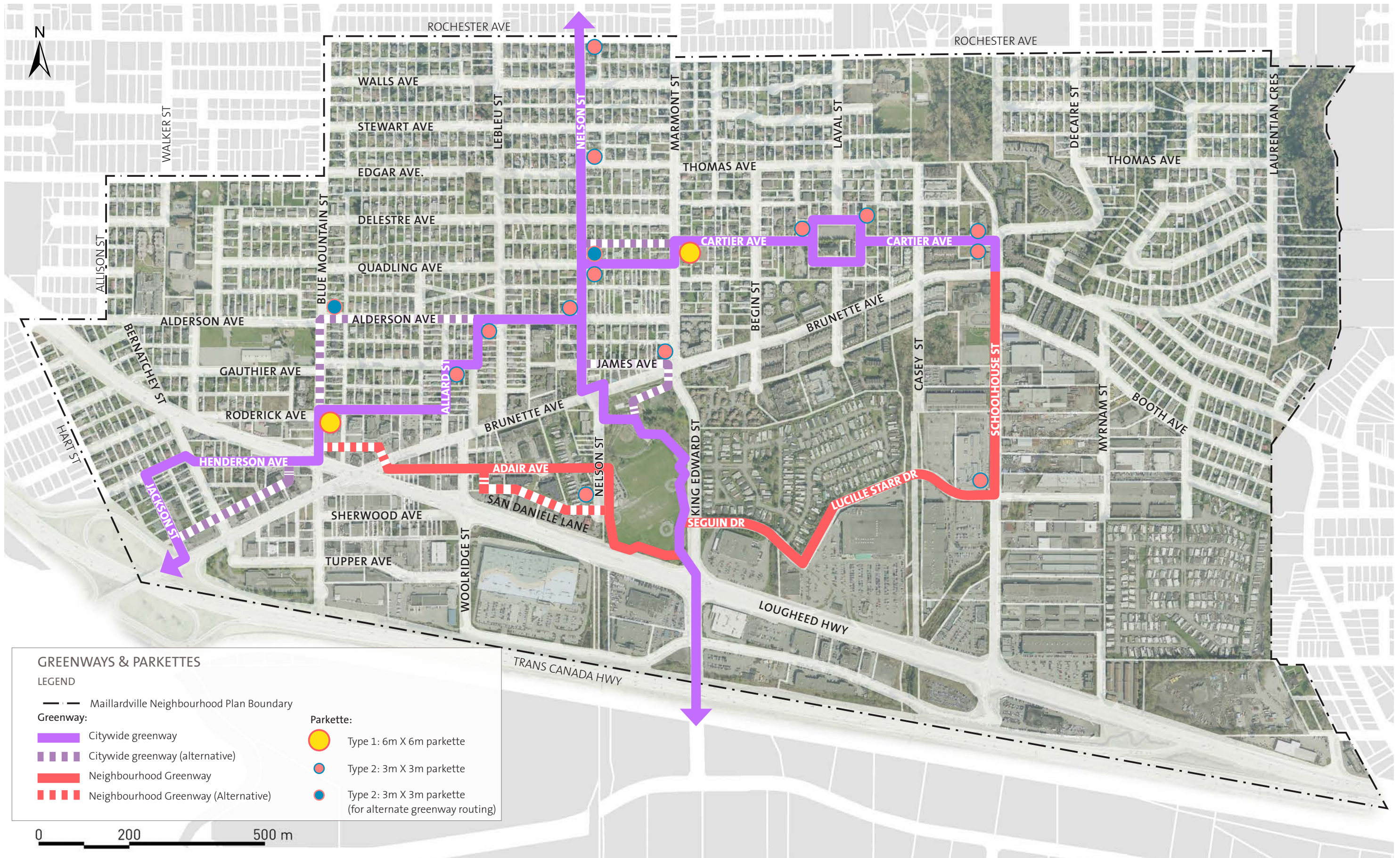

Figure-24 Greenways & Parkettes

This page intentionally left blank

4.3.1 Neighbourhood Greenways

The Greenway routes shown on Figure-24 illustrate the integration of Maillardville Neighbourhood Greenways within the wider City of Coquitlam Greenway network.

Maillardville Neighbourhood Greenways include the following two street conditions:

1. Local Streets
2. Schoolhouse Street (Arterial)

Guidelines:

- a. Implement the design elements illustrated in Figure-25, Figure-26, Figure-27, and Figure-28 and the specifications in Section 5.0, for all Neighbourhood Greenway frontages.
- b. Where a greenway route is addressed by a standard of design and space allocation higher than the specifications in this section, the higher standard shall take precedence (i.e. Adair Avenue commercial frontages, Laval Square, and frontages along the historic 'processional route').
- c. Provide infrastructure for hanging flower baskets, banners and seasonal lighting on the light poles, in accordance with the requirements set out in Figure-31 (page 51) of Section 4.4, to demarcate the historical 'processional route.'
- d. Integrate 6m x 6m parkettes at key arterial/local Road intersections related to top of hills for rest stop opportunities (Type 1: see Figure-24).
- e. Integrate 3m x3m parkettes at local road intersections with regular spacing (Type 2: see Figure-24) related to top of hills for rest stop opportunities.
- f. Incorporate pedestrian level lighting on all multi-use pathways.



Image-20 Neighbourhood Greenway



Image-21 Neighbourhood Greenway

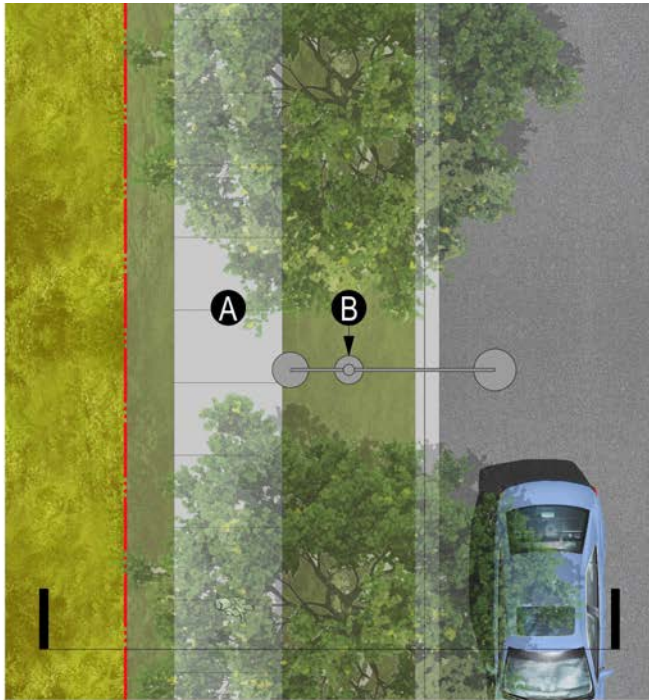

A CIP Concrete

B Street Lighting Type 1 or 2 (depending on reach)

Figure-25 Plan-View: Neighbourhood Greenways on Local Streets

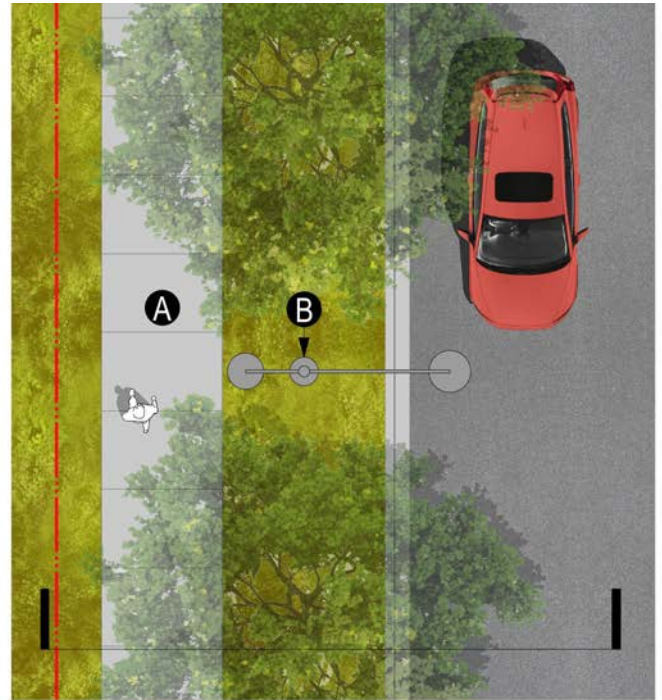

A CIP Concrete

B Street Lighting Type 1 or 2 (depending on reach)

Figure-27 Plan-View: Neighbourhood Greenway on Schoolhouse Street

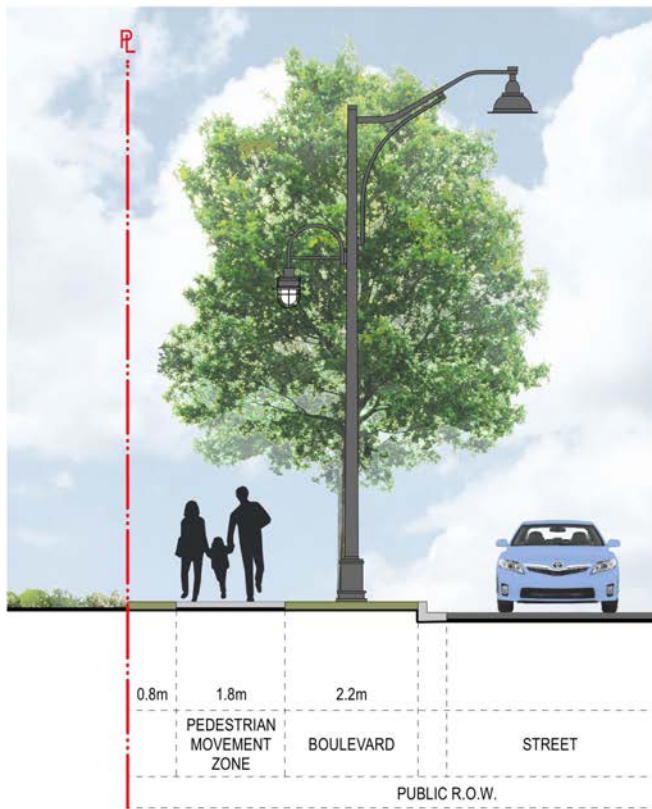

Figure-26 Cross-Section: Neighbourhood Greenways on Local Streets

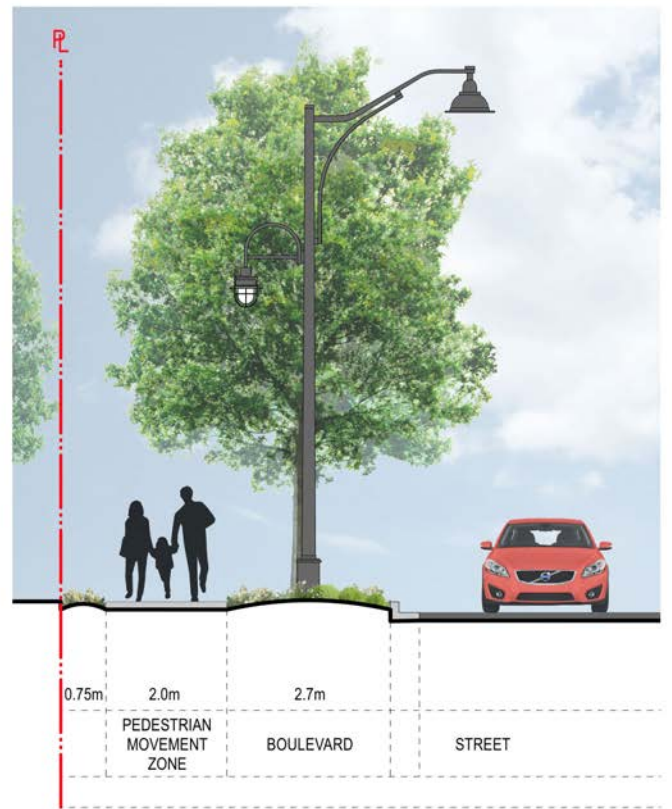

Figure-28 Cross-Section: Neighbourhood Greenway on Schoolhouse Street

4.3.2 Greenway Parkette Type 1 - Arterial Road and Local Street Intersection

The parkettes at arterial/local road intersections are shown on Figure-24 (page 41). They will occupy a 6m x 6m triangle of the road right-of-way on one corner of the intersection, providing a small area with seating and planting. Planting and site furniture should not block the vehicular sight lines. Refer to the City of Coquitlam standards for height restrictions.

Guidelines

- a. Implement the design elements illustrated in Figure-29 and the specifications in Section 5.0 for the 6m x 6m parkette locations identified on Figure-24.
- b. Provide ornamental planting at each end of the bench to enhance the feeling of the space and give it visual interest along the Greenway Route, as per the parkette species identified in Figure-35 (page 71).
- c. Include a central street tree planting, as per the species identified in Figure-35, in crushed stone paving.
- d. Ultimate locations and need for proposed 'parkettes' will be determined through the development application review process.



Image-22 Parkette Planting and Site Furniture



Image-23 Parkette Quality and Scale of Lighting

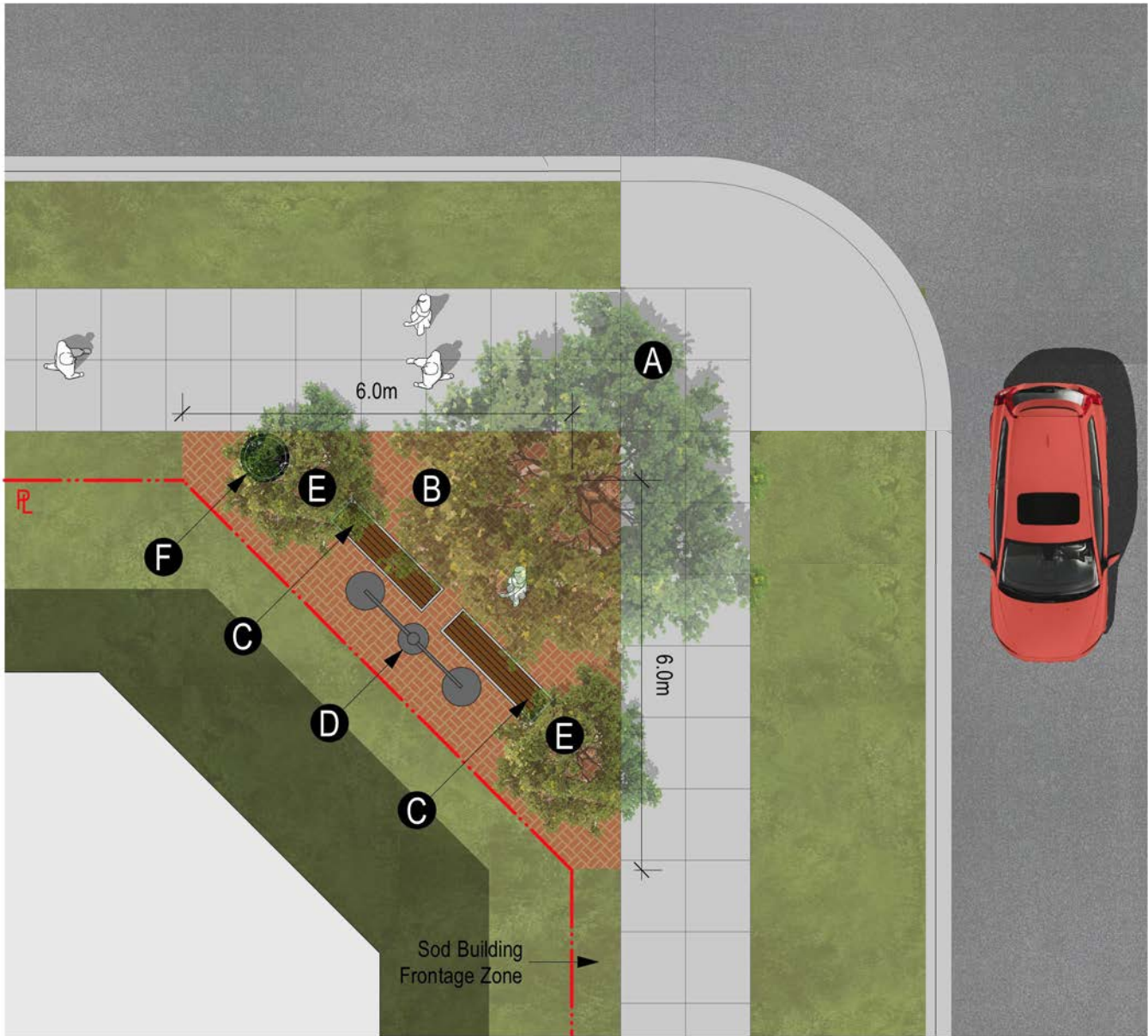

A CIP Concrete

C Bench Type 1 or 2

E Planter Box Type 1 or 2

B Crushed Stone Paving

D Pedestrian Lighting

F Litter Receptacle

Figure-29 Plan - Parkette Type 1 - Intersection of Local and Arterial Streets

4.3.3 Greenway Parkette Type 2 - Local Street Intersection

The parkettes at local road intersections are shown on Figure-24 (page 41). They will occupy a 3m x 3m triangle of the road right-of-way on one corner of the intersection and provide a small area with seating and planting. Planting and site furniture should not block the vehicular sight lines. Refer to the City of Coquitlam standards for the height restrictions.

Guidelines

- a. Implement the design elements illustrated in Figure-30 and the specifications in Section 5.0 for the 3m x 3m parkette locations identified on Figure-24.
- b. Plant a pair of small ornamental trees on opposite ends of the bench in planter boxes, as per the parkette species identified on Figure-35.
- c. Ultimate locations and need for proposed 'parkettes' will be determined through the development application review process.



Image-24 Parkette Site Furniture Relationship to Street

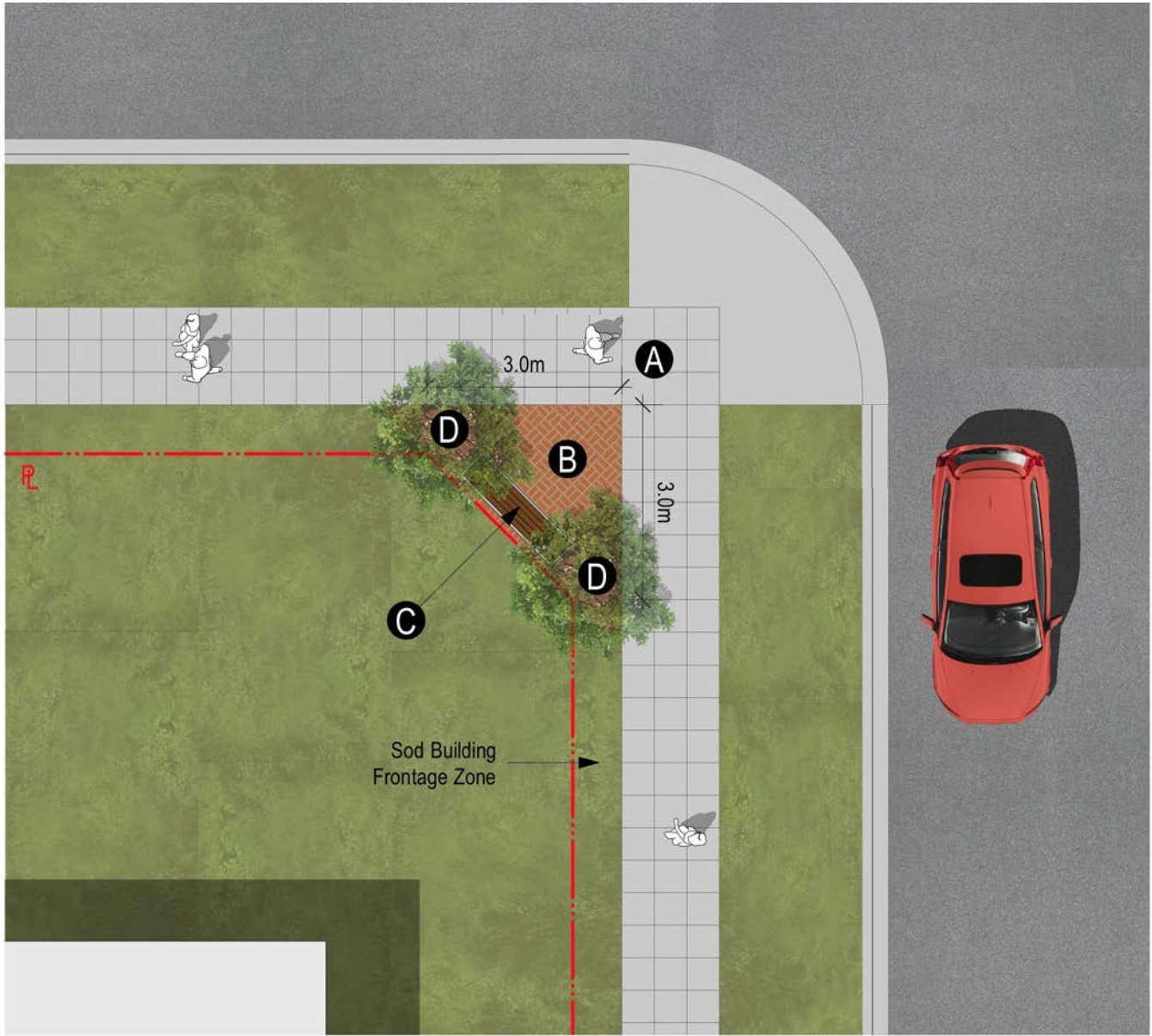

- A** CIP Concrete

B CIP Concrete Colored and Stamped
- C** Bench Type 1 or 2

D Planter Box Type 1 or 2

Figure-30 Plan - Parkette Type 2 - Intersection of Local Streets



Image-25 Higher-Density Residential Street with Prominent Street Tree Planting

4.4 Processional Route

The 'Processional Route' in Maillardville is a walking route that extends from Laval Square to the Clock Tower Square on Brunette Avenue, where it loops around Adair Avenue and Woolridge Street, returning to Brunette Avenue. The processional route, historically, held ceremonial significance as a place for community 'parades' that marked special occasions, events and important holidays. This route, as illustrated in Figure-31, is symbolically reflected along the streetscape. The processional route uses the same streetscape design requirements and details, including site furnishings, but is distinguished from other streetscapes in terms of colour, planting materials and the provision of additional infrastructure.

Design Intent:

- Recognize the community procession that used occur around Laval Square and along Brunette Avenue.

- Identify the route through unique colour, street trees and other plantings and streetlight pole infrastructure that supports street banners, hanging flower baskets and seasonal lighting.
- Infuse the area with heritage inspired elements to recognize the historical cultural values of the neighbourhood.
- Develop a streetscape corridor that provides a safe and comfortable walking routes.
- Create grand loops for both the east and west terminus of the historical 'processional route'.

Guideline:

- a. Provide enhance streetscape infrastructure for hanging flower baskets, street banners and seasonal lighting receptacles on the street light poles in accordance with Figure-31 to demarcate the historic 'processional route'.



Image-26 Historic Procession

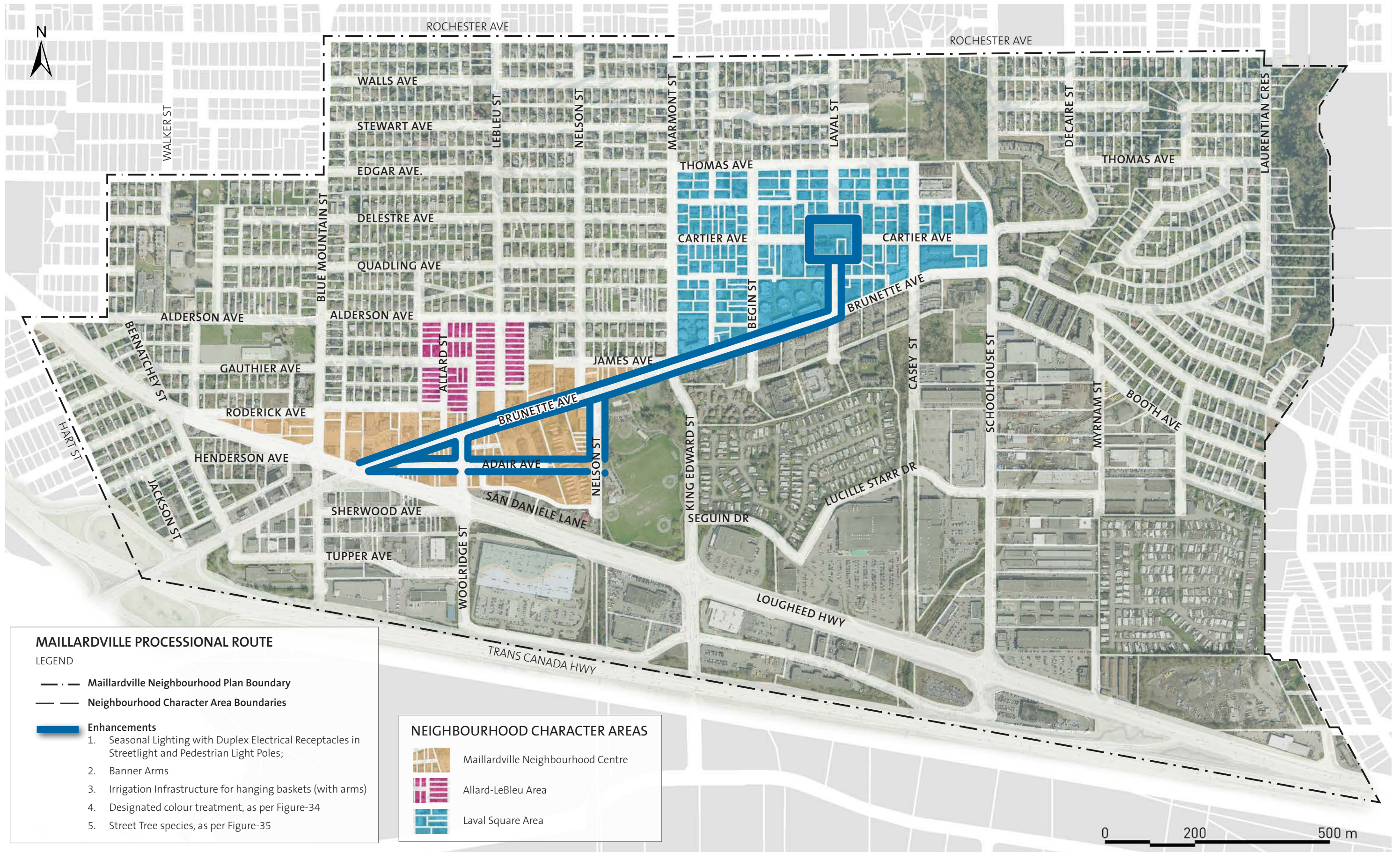

Figure-31 Enhanced Streetscape Infrastructure

This page intentionally left blank

5.0 Streetscape Details

The different character areas within Maillardville each have different land development uses and with different community amenities. As such, these areas warrant specific types of site elements. Two overarching principles of this document significantly impact the site element selection and layout. The first is the intent to create a “unique sense of place within the bigger city context” of the City of Coquitlam. The second is the intention to create a “visually apparent neighbourhood centre”. These two principles have led to the development of these sets of site elements that are unique amongst themselves and share common features.

Section 5.0 covers the following key components:

- 5.1 Paving Materials
- 5.2 Site Furnishings (including colour)
- 5.3 Street Trees and Landscape Planting Selections
- 5.4 Lighting



Image-27 Streetscape Element Bollard



Image-28 Streetscape Element Hanging Flower Basket



Image-29 Streetscape Element Tree Grate



1a

CIP Concrete - Sidewalk at Seating Area

Material: Cast in Place (CIP) Concrete

Finish: Broom finish, saw cut control joint

Saw Cut Pattern Dimension: Align jointing pattern with seating pocket; achieve a 2:1 ratio with long side perpendicular to travel.



1b

CIP Concrete Sidewalk

Material: Cast in Place (CIP) Concrete

Finish: Broom finish, saw cut control joint

Saw Cut Pattern Dimension: Achieve a square pattern dimension.



2

CIP Concrete - Stamped and Coloured

Material: Cast in Place (CIP) Concrete

Colour: Bomanite Brick Red (integral), Bomanite Rust Brown (Releasing Agent)

Dimension: 195 mm x 90 mm; Spacing 12 mm

Supplier: Creative Coloured Concrete, North Vancouver, BC

Stamped Pattern: Basket Weave Pattern, parallel to the curb

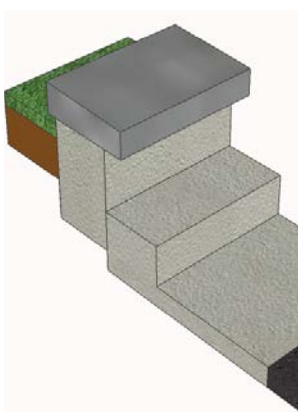

3

Planter Wall with Stone Cap

Wall:

Material: Cast in Place Concrete

Finish: Form Finish, Saw Cut Joints

Dimension: 0.2m(h)x0.15m(w) Exposed

Stone Cap:

Material: Black Basalt

Finish: All Exposed Face to be Split Face

Dimension: 0.05m(h)x0.25m(w)

Supplier: Bedrock Granite, Coquitlam

4

Curb

Dimension: Refer to City of Coquitlam Standard

5

Asphalt

Dimension: Refer to City of Coquitlam Standard

6

Crushed Stone Paving in Type 1 Parkettes

Material: Crushed Granite with Organic Binder

Supplier: Bedrock Granite, Coquitlam

5.2 Site Furnishing

The exact locations and frequency of site furnishing elements are to be determined during functional design on a case-by-case basis at the time of redevelopment. As a rule, the quantity and location of these furnishings should be generously applied, as reasonable and appropriate, based on the criteria provided and in concurrence with other perimeter works and services, city bylaws and as determined by the General Manager Planning and Development.

Developers may propose additional streetscape design components beyond the minimum provisions identified for each frontage type, and in some cases, the City may request additional elements on a case-by-case basis, as deemed appropriate by the General Manager Planning and Development.



Image-30 Site Furnishing Quality and Scale of Street Lighting



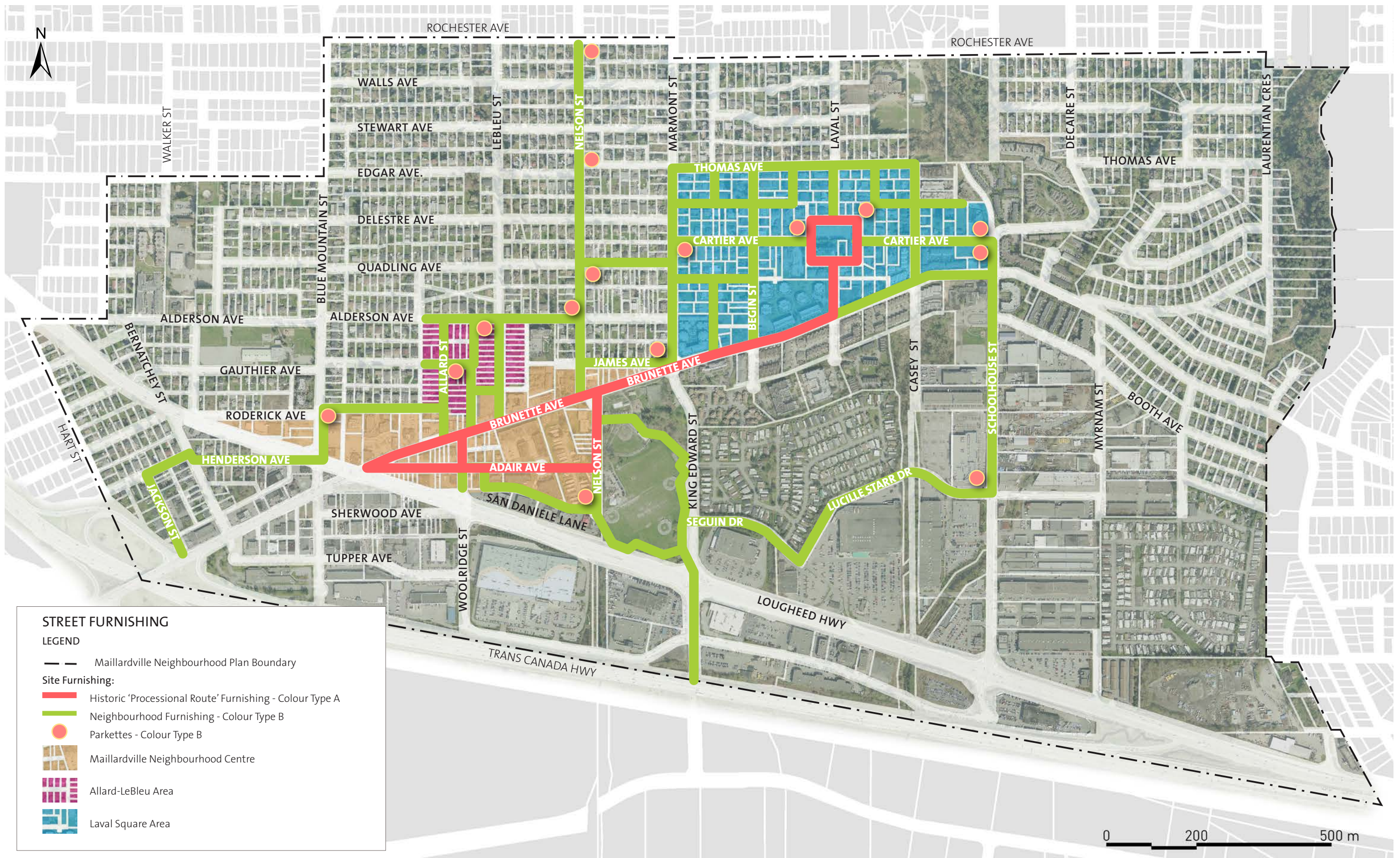

Figure-34 Street Furnishing

This page intentionally left blank

5.2.1 Bench - Type 1

Model: Series 10 Bench (Models 1A, 2A, 3A & 4A)

Colour: **Type A:** Black with Ipe hardwood slat
Type B: Graphite with Ipe hardwood slat

Materials: Standard Aluminum Cast

Finish: Polyester Powder Coating

Frequency: Minimum of 2 benches every 16.6 metres

Branding: Stylized Maillardville 'M' welded between the bench legs - For Model 3A

Supplier: Frances Andrews Site Furnishings Limited
Surrey, BC

Sustainability: Recycled content



C10-1A

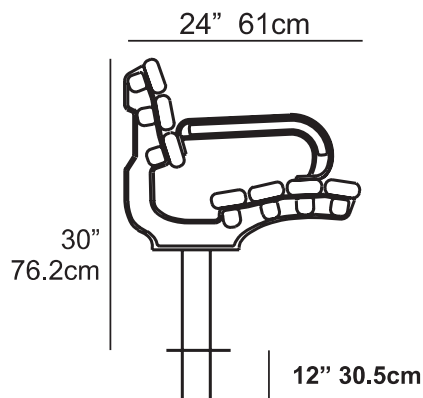

C10-2A

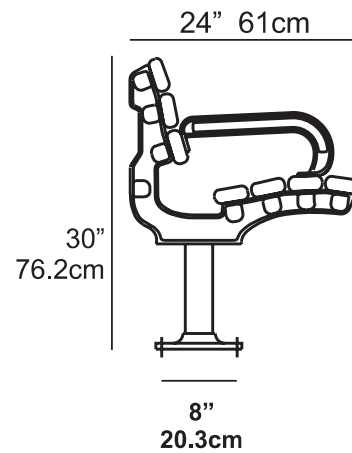

C10-3A

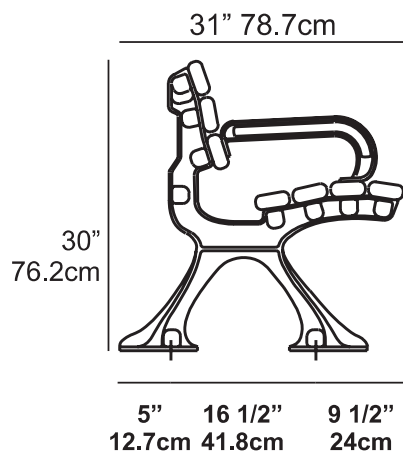

C10-4A

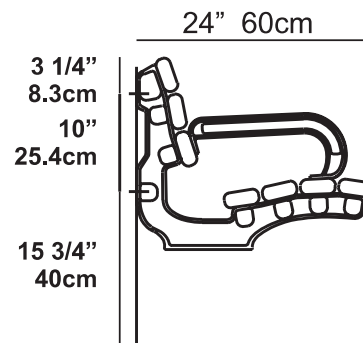

5.2.2 Bench - Type 2

- Model:** Series 10 Bench (Models 1A, 2A, 3A & 4A)
- Colour:** **Type A:** Black with Ipe hardwood slat
Type B: Graphite with Ipe hardwood slat
- Materials:** Standard Aluminum Cast
- Finish:** Polyester Powder Coating
- Frequency:** Minimum of 2 benches every 16.6 metres
- Branding:** Stylized Maillardville 'M' welded between the bench legs - For Model 5
- Supplier:** Frances Andrews Site Furnishings Limited
Surrey, BC
- Sustainability:** Recycled content

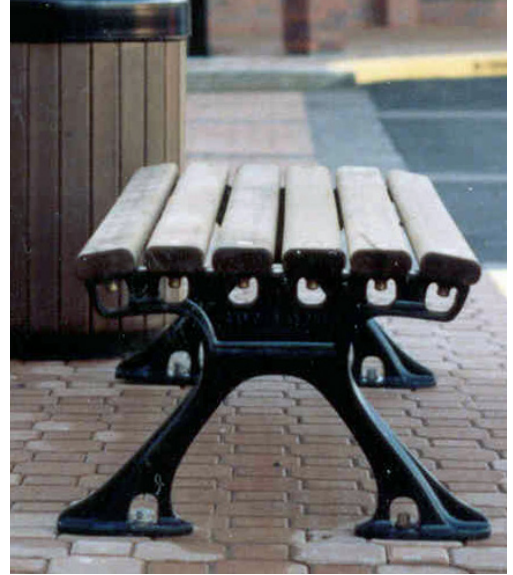

C10-51

23 5/16" 59.2cm

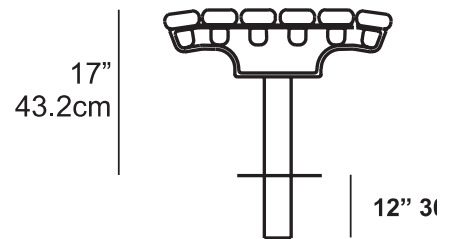

C10-5

23 5/16" 59.2cm

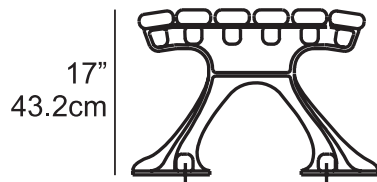

5 1/2" 14 1/2" 5 1/2"
14cm 36.8cm 14cm

C10-52

23 5/16" 59.2cm

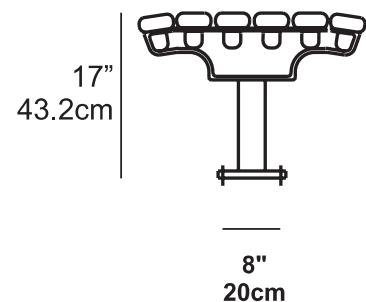

5.2.3 Bicycle Rack Type 1

- Model:** R7573B
- Size:** 36 1/2"
- Colour:** Type A: Black
Type B: Graphite
- Material:** Ductile Iron
- Finish:** Proprietary powder coat
- Frequency:** Minimum of 5 every 20 metres: grouped and aligned perpendicular to the curb
- Supplier:** Reliance Foundry, Surrey, BC
- Sustainability:** Recycled content, Recyclable



5.2.4 Bicycle Rack Type 2

- Model:** Series 12, (BR34 and BR36)
- Colour:** Type A: Black
Type B: Graphite
- Materials:** Steel Pipe
- Finish:** Polyester Powder Coating
- Frequency:** Minimum of 1 every 20 metres: aligned perpendicular to the curb
- Branding:** Stylized Maillardville 'M' welded inside the exterior rings
- Supplier:** Frances Andrews, Surrey, BC
- Sustainability:** Recycled content

E12-BR36

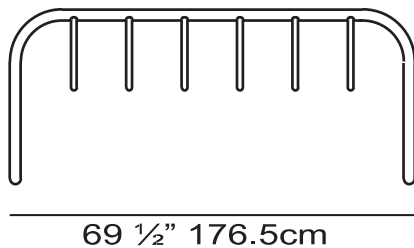

13 7/8" 35.2cm

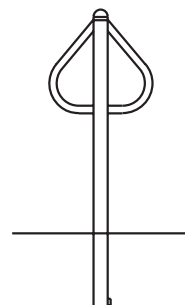

13 7/8" 35.2cm

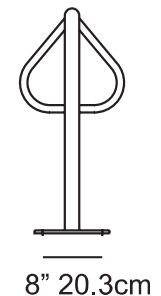

30"
76.2cm

30"
76.2cm

12"
30.5cm

8" 20.3cm

5.2.5 Litter Receptacle Type 1

Model:	Series 8 Receptacles (Model 5)
Colour:	Type A: Black Type B: Black
Materials:	Plastic dome lid, galvanized liner, Epi hardwood
Finish:	Plastic, wood
Frequency:	Minimum of 1 every 20 metres
Accessories:	Rain Dome lid
Supplier:	Francis Andrews, Surrey, BC
Sustainability:	Recycled content

R8-5

22" 55.9cm

39 1/2"
100cm

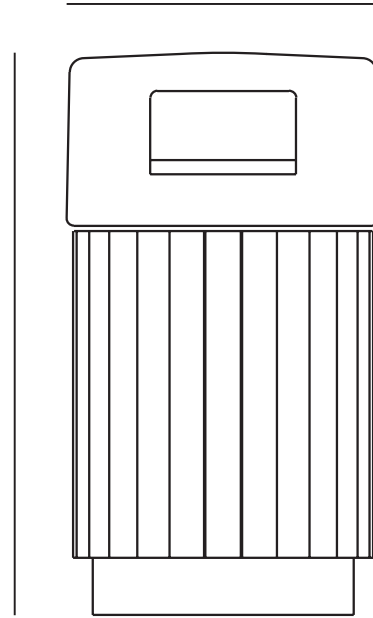

5.2.6 Heritage Inspired Fire Hydrant

Model:	"T.C." H105 Heritage Hydrant
Colour:	Determined by Fire Chief
Supplier:	Terminal City Iron Works Ltd., Vancouver, BC



5.2.7 Bollards

Model:	R7573
Size:	36 1/2"
Colour:	Type A: Black Type B: Graphite
Material:	Ductile Iron
Finish:	Proprietary powder coat
Supplier:	Reliance Foundry, Surrey, BC
Mounting:	Fixed and Removable
Accessories:	Variety of chain links and padlock
Sustainability:	Recycled content, recyclable



5.2.8 Tree Grate

Model:	ST48
Colour:	Black
Material:	Ductile Iron
Finish:	Unfinished or Oiled
Supplier:	Dobney Foundry Ltd., Surrey, BC
Sustainability:	Recycled content, recyclable
Installation:	Cast in place frame



5.2.9 Planter Box Type 1

- Model:** MLP 200
- Colour:** Type A: Black
Type B: Graphite
- Materials:** Heavy-duty steel flat bar, plastic liner, spun metal lid
- Finish:** E-Coat Rust Proofing powder coat system
- Supplier:** Maglin, Calgary, AB
- Sustainability:** Recycled content, recyclable

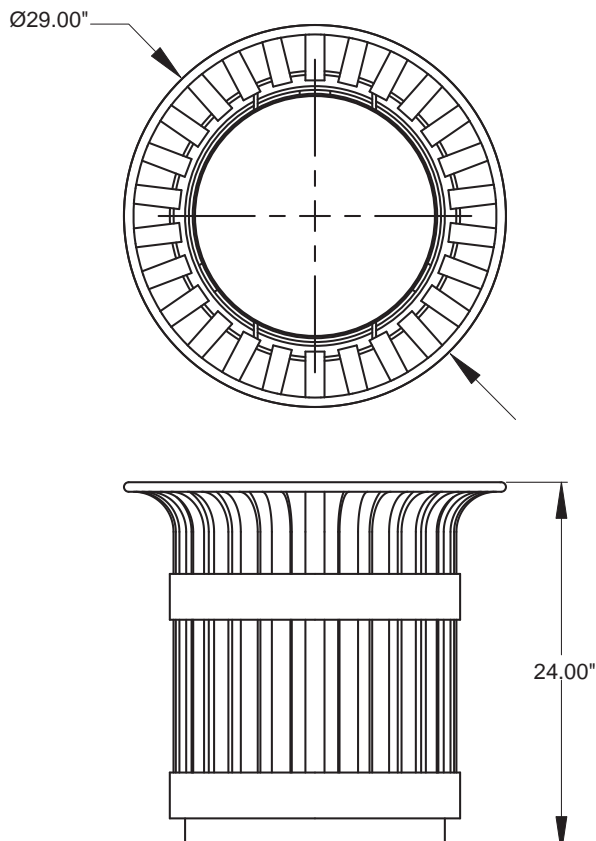

- DIMENSIONS:**
- | | |
|-----------|------------------|
| Height: | 24.00" (60.9 cm) |
| Diameter: | 29.00" (73.7 cm) |
| Weight: | 125lbs (57kg) |

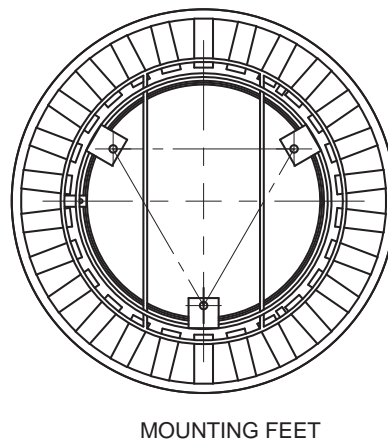

5.2.10 Planter Box Type 2

Model: MLWR400-25
Colour: Type A: Black with dark brown slats
Type B: Graphite with dark brown slats
Materials: H.S. Steel tubes, HDPC Slats
Finish: E-Coat Rust Proofing powder coat system
Supplier: Maglin, Calgary, AB
Sustainability: Recycled content, recyclable



DIMENSIONS: Height: 30.00" (76.2 cm)
Width: 21.00" (53.3 cm)
Depth: 21.00" (53.3 cm)
Weight: 127lbs (57kg)
Liner Capacity: 25.0 Gallons
94.6 Litres

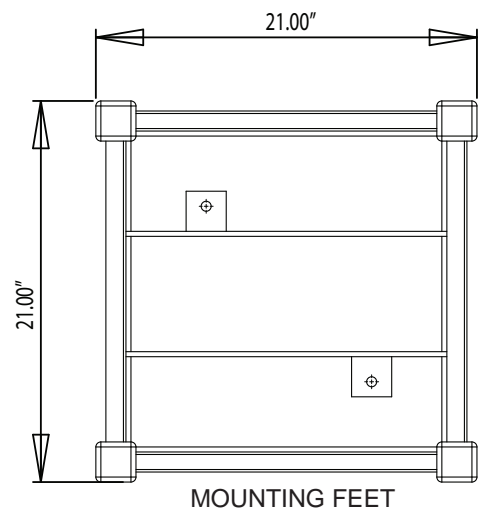
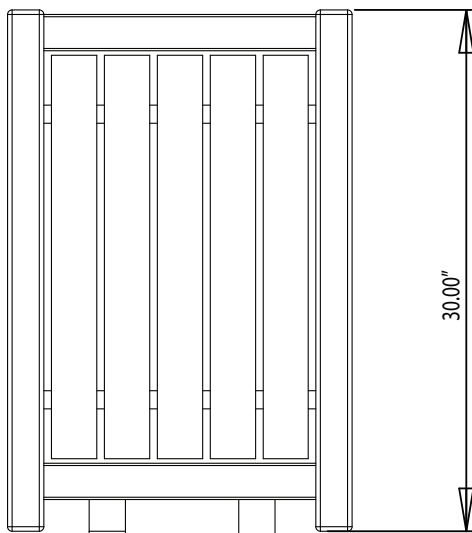

5.3 Street Trees and Landscaping

The planting scheme should contribute to developing the unique sense of Maillardville within the City of Coquitlam and help achieve several best management sustainability objectives. The character of the planting should be reflective of an old European town to honor the heritage and history of the neighbourhood in an authentic way.

Greenway and Parkette Plantings

The plantings in the parkettes should primarily emphasize the sense of place within Maillardville as gateways to the neighbourhood, particularly for pedestrians and cyclists traveling along the Citywide Greenway. A limited palette of plants with high aesthetic value and easy identification that are present throughout the neighbourhood should be used.

Street Trees

The appropriate street tree selection is critical to the overall urban forest health character of the area and selecting species that are long lived and have minimal impact on the surrounding public realm elements allows for reduced maintenance costs. The street tree plantings should seek to establish a continuous tree canopy along the primary street corridors of the character areas.

Building Frontage Zone Plantings

Within the commercial frontage areas the Building Zone plantings should, if there are no plantings on the development parcel, be an extension of the Site Furnishings zone or Boulevard plantings to create a strong sense of continuous public realm from curb to building face. In residential frontage areas, or areas of lower density residential, the development parcel planting should come up to the back of sidewalk where there are no utility easement restrictions.

Furnishing / Boulevard Zone Plantings

The appropriate plantings in the Site Furnishings zone and the Boulevard will add seasonal interest, biodiversity, colour, green character, and environmental benefits. It will also help create a sense of place. The plans suggest critical areas where plantings should occur but also indicate that there are opportunities for developers and landowners to “adopt” portions of the Boulevard for additional planting areas.

Design intent:

- To have majestic street trees throughout the Maillardville neighbourhood
- To have long lived and healthy large scale street trees
- To have street trees that address storm water management, biodiversity, and that offer great environmental benefits
- To create a unique sense of place for Maillardville within the greater city context
- To create distinction for each of the character areas while still feeling unified with the rest of the neighbourhood.

Guidelines:

- a. Provide street trees and other plantings along streetscapes in accordance with Figure-35 and the planting lists in this section.
- b. Irrigation systems should be provided for all raised planting beds, planters, hanging baskets and trees in hard surface circumstances.
- c. The total number of street trees will be maximized. The actual spacing of the trees will vary due to demands for other uses along the streetscape.
- d. Refer to City of Coquitlam Supplementary Specifications and Detailed Drawings to MMCD 2000 Edition Section 2960 for additional information.

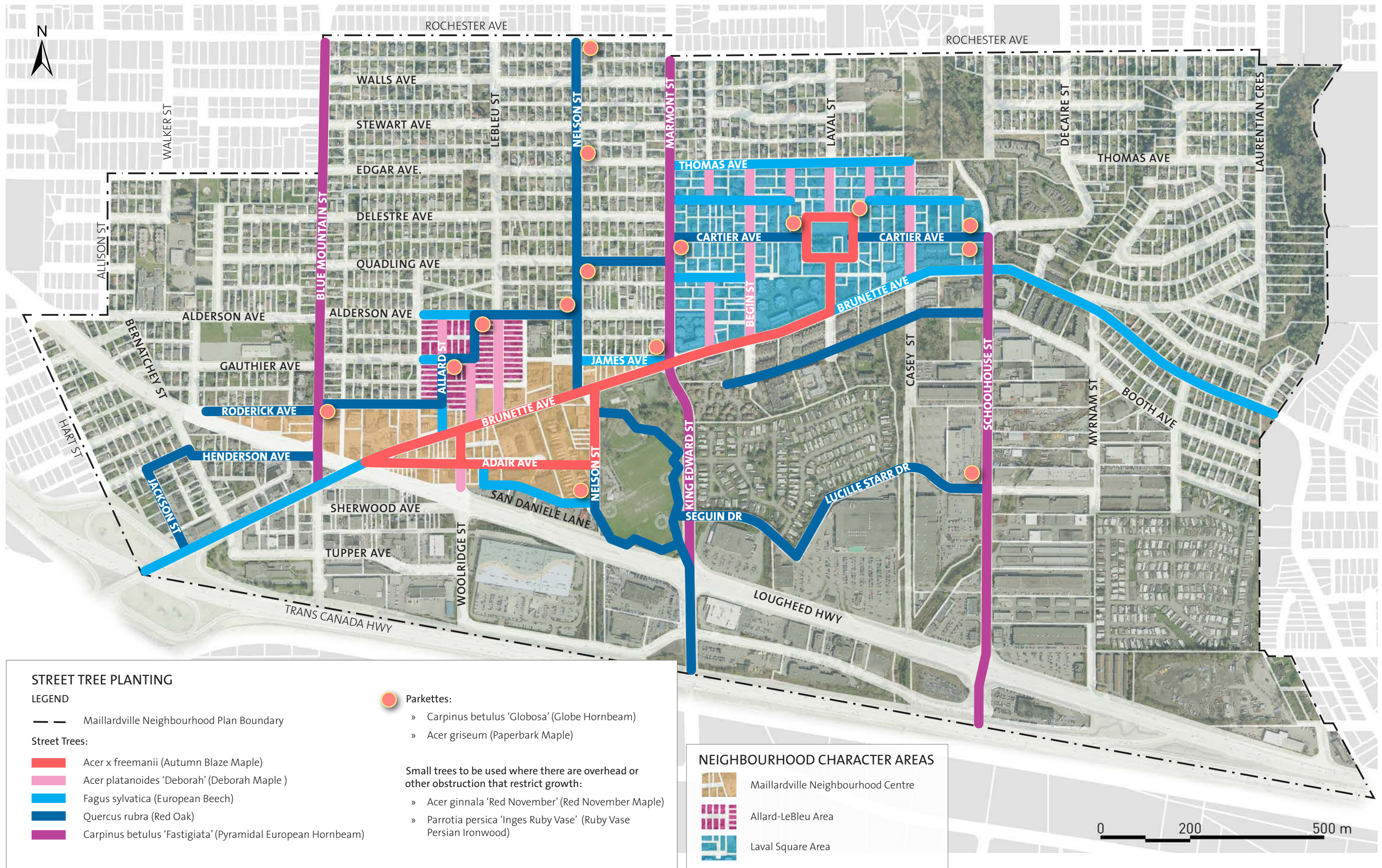

Figure-35 Street Tree Plantings

This page intentionally left blank

5.3.1 Brunette Avenue Plantings

Recommended Planting List

Scientific Name

Buxus microphylla 'Winter Gem'
Choisya ternata
Epimedium x rubrum
Iris pallida variegata
Lavandula angustifolia 'munstead'
Rosa meidiland 'Pink'
Spiraea betulifolia 'Tor'

Common Name

Winter Gem Boxwood
Mexican Orange
Red Barrenwort
Variegated Sweet Iris
Munstead lavender
Meidiland Pink Rose
Tor Birchleaf Spirea



Iris pallida variegata



Spiraea betulifolia 'Tor'



Choisya ternata



Buxus microphylla 'Winter Gem'



Lavandula angustifolia 'munstead'

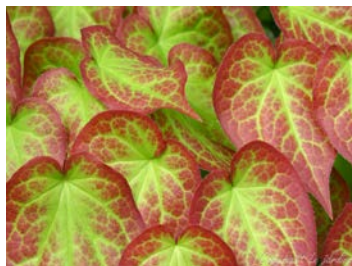

Epimedium x rubrum



Rosa meidiland 'Pink'

5.3.2 Maillardville Neighbourhood Centre - Commercial Frontage Plantings

Recommended Planting List

Scientific Name

Alchemilla mollis
 Buxus microphylla 'Winter Gem'
 Epimedium x rubrum
 Helictotrichon sempervirens
 Lavandula angustifolia 'munstead'
 Rosa 'Meidiland White'
 Rudbeckia fulgida 'Goldsturm'
 Sedum telephium 'Autumn Joy'

Common Name

Lady's Mantle
 Winter Gem Boxwood
 Red Barrenwort
 Blue Oat Grass
 Munstead lavender
 White Meidiland Rose
 Goldsturm Coneflower
 Sedum 'Autumn Joy'



Sedum telephium 'Autumn Joy'



Buxus microphylla 'Winter Gem'



Lavandula stoechas



Epimedium x rubrum



Helictotrichon sempervirens



Rudbeckia fulgida 'Goldsturm'



Rosa 'Meidiland White'



Alchemilla mollis

5.3.3 Maillardville Neighbourhood Centre - Residential Frontage Plantings

Recommended Planting List

Scientific Name

Buxus microphylla 'Winter Gem'
Crocosmia 'Lucifer'
Epimedium x rubrum
Gaultheria shallon
Spiraea x bumalda x 'Goldflame'
Syringa vulgaris
Lavandula angustifolia 'munstead'

Common Name

Winter Gem Boxwood
Crocosmia
Red Barrenwort
Salal
Goldflame Spiraea
Common Lilac
Munstead lavender



Buxus microphylla 'Winter Gem'



Lavandula stoechas



Syringa vulgaris



Epimedium x rubrum

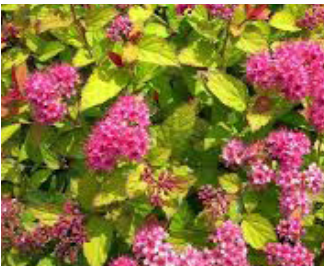

Spiraea x bumalda x 'Goldflame'



Crocosmia 'Lucifer'



Gaultheria shallon

5.3.4 Laval Square Character Area Plantings

Recommended Planting List

Scientific Name

Erica carnea 'Springwood Pink'
Buxus microphylla 'Winter Gem'
Echinacea pupurea
Epimedium x rubrum
Euphorbia myrsinites
Lavandula angustifolia 'munstead'

Common Name

Springwood Pink winter heath
Winter Gem Boxwood
Purple Coneflower
Red Barrenwort
Myrtle Spurge
Munstead lavender



Erica carnea 'Springwood Pink'



Buxus microphylla 'Winter Gem'



Lavandula angustifolia 'munstead'



Epimedium x rubrum



Echinacea pupurea



Euphorbia myrsinites

5.3.5 Allard-LeBleu Character Area Plantings

Recommended Planting List

Scientific Name

Allium
Artemisia 'Powis Castle'
Buxus microphylla 'Winter Gem'
Epimedium x rubrum
Euphorbia amygdaloides robbiae
Hydrangea macrophylla 'Lanarth White'
Lavandula angustifolia 'munstead'

Common Name

Allium
Wormwood
Winter Gem Boxwood
Red Barrenwort
Mrs. Robb's bonnet
Lanarth White Lacecap
Munstead lavender



Allium



Epimedium x rubrum



Euphorbia amygdaloides robbiae



Artemisia 'Powis Castle'



Buxus microphylla 'Winter Gem'



Lavandula angustifolia 'munstead'



Hydrangea macrophylla 'Lanarth White'

5.3.6 Parkette Plantings and Tree Selection

Recommended Planting List

Scientific Name

Choisya ternata
Forsythia
Spirea bumalda 'Anthony Waterer'
Syringa patula 'Miss Kim'
Sedum 'Autumn Joy'
Saxifraga x urbium 'London Pride'

Common Name

Mexican Orange Blossom
Forsythia
Anthony Waterer Spirea
Miss Kim Lilacs
Autumn Stonecrop
London Pride

Recommended Tree List (as identified in Figure-34)

Scientific Name

Corpinus betelus 'Globosa'
Acer griseum

Common Name

Globe Hornbeam
Paperbark Maple



Forsythia



Syringa patula 'Miss Kim'



Saxifraga x urbium 'London Pride'



Choisya ternata



Sedum 'Autumn Joy'

5.3.7 Rain Garden Plantings

Recommended Rain Garden List

Scientific Name

Common Name

Tree

Acer x freemanii 'Autumn Blaze'
Nyssa sylvatica

Autumn Blaze Maple
Black Gum

Emergent Plants

Carex glauca
Carex elata 'Aurea'
Carex obnupta
Juncus effusus
Juncus tenuis
Juncus acuminatus
Iris douglasiana
Iris missouriensis
Scirpus lacustris
Scirpus microcarpus

Blue Sedge
Bowles' golden sedge
Slough Sedge
Common Rush
Slender Rush
Tapered Rush
Douglas Iris
Western Blue Iris
Hard Stemmed Bullrush
Small Fruited Bullrush

Shrubs - Deciduous

Cornus sericea
Ribes lacustre
Symphoricarpus albus

Red Osier Dogwood
Black Gooseberry
Snowberry

Shrubs - Evergreen

Gaultheria shallon
Ledum groenlandicum

Salal
Labrador Tea

Fern

Blechnum spicant
Polystichum munitum
Matteuccia struthiopteris

Deer fern
Western Swordfern
Ostrich Fern

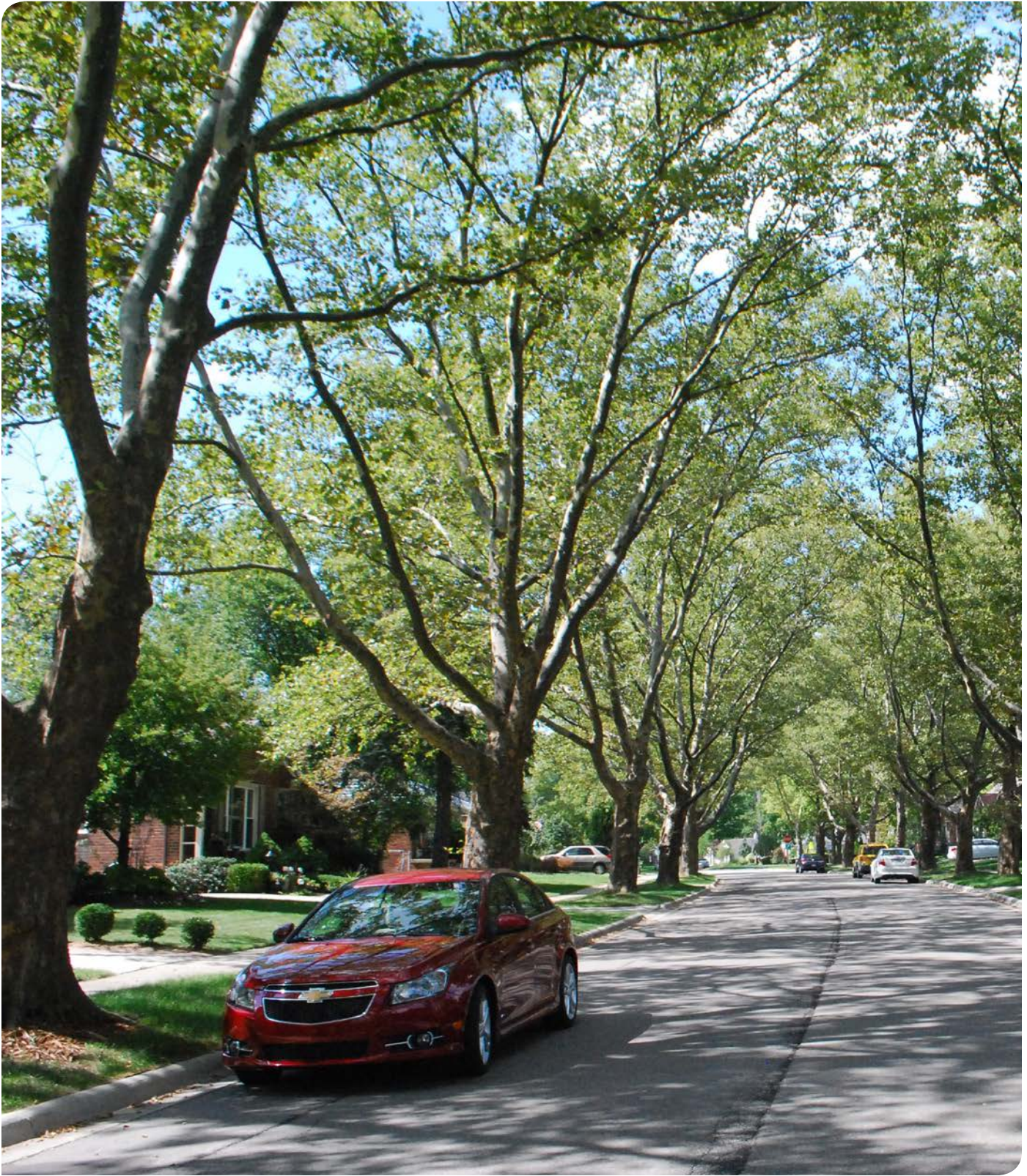

Image-31 Tree Lined Street

5.4 Lighting

The lighting elements will complement the heritage features of the existing streetscape and build upon that aesthetic with currently available, energy efficient, and durable poles and current technology, light fixture options. Improvements to the public realm will include new lights in all character areas based upon the products listed here.

As indicated on Figure-31 (Page 51), street and pedestrian light poles along the Processional Route are to support a hanging flower basket and/or banner. Poles in these areas should be equipped with internal irrigation conduit for a drip emitter system and have banner/basket arm accessories.

Street and pedestrian light poles along the Processional Route should come equipped with exterior rated GFCI plugs to enable seasonal lighting installations. A guy wire system at a minimum elevation of 2.4m should be provided between poles without the plugs to support low voltage lighting extensions. See Figure-31 (Page 51) for areas of seasonal lighting.

Street

Two options for street lighting are provided but developers should work out the correct spacing, arm lengths and fixture placement based on the industry standard modeling and requirements, BC Building Code, road classification, and City of Coquitlam requirements. The spacing of the light poles should be maximized in order to reduce the impact on the street trees.

Pedestrian

Pedestrian lighting specifications are shown on the following pages. Where portions of the street or character area have been previously improved based on this document the developer is to simulate the placement, model, and spacing as much as the current requirements allow. This is to ensure a uniform public realm is achieved in the end.

Parkette

Safe and comfortable lighting is to be provided for Type 1 Greenway parkettes. Lighting levels are to meet with industry standards, BC Building Code, and the City of Coquitlam requirements. Pedestrian level lighting rather than street level lighting fixtures should be used. An exterior rated GFCI plug to enable seasonal lighting installations should be provided at a minimum elevation of 2.4m.

Design Intent:

Guidelines:

- a. Street and pedestrian light spacing
- b. Incorporate pedestrian scale lighting for streetscapes within all three Character Areas and the Greenway Parkette Type 1 (Page 45-46).

5.4.1 Street Type 1 (View A)

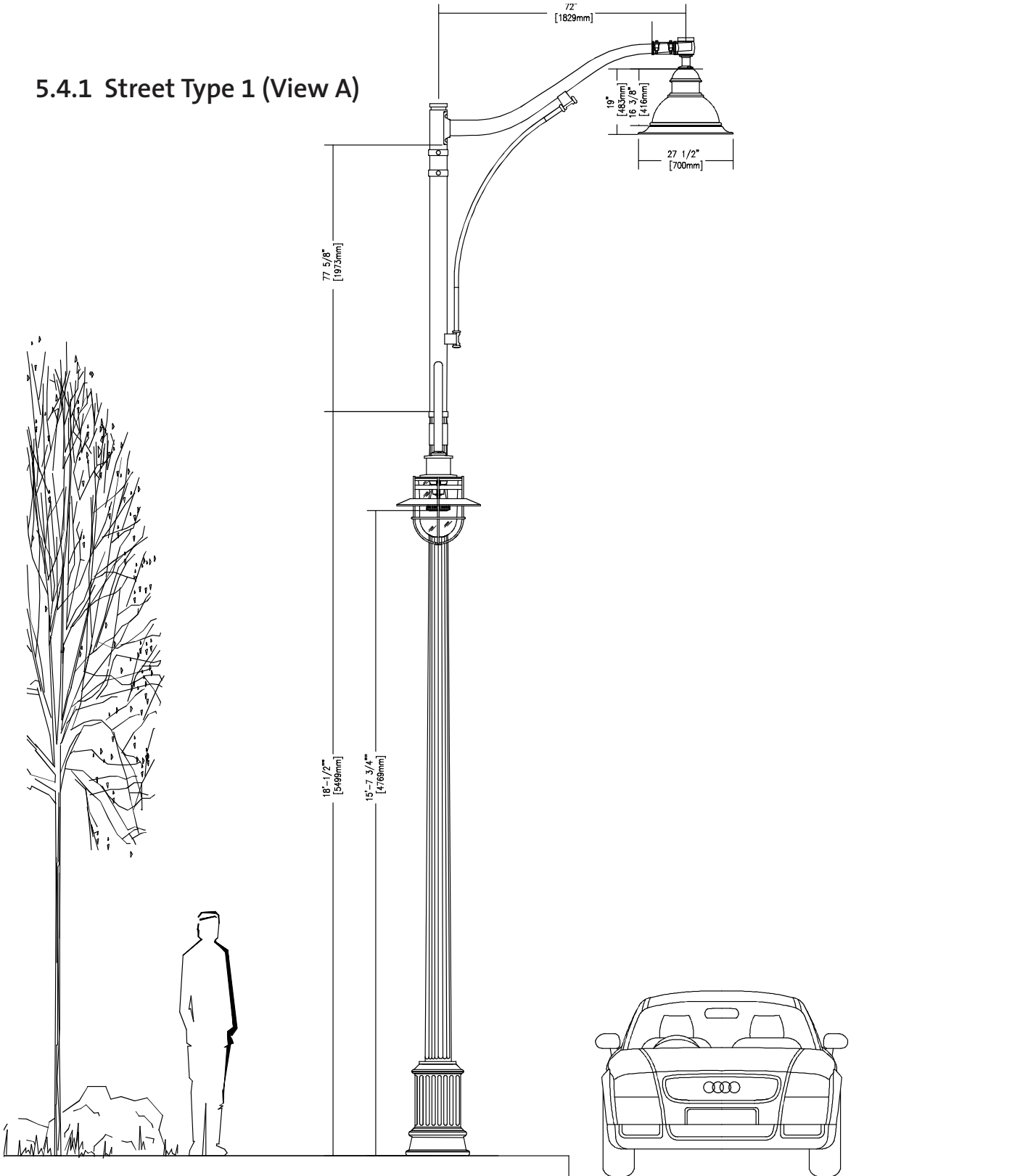

**Metrolume
Lighting System Inc.**

PO Box 12009, RPO Murrayville
Langley, BC, V3A 9J5
Phone: 778-278-3515 Fax: 778-278-3516
www.metrolume.ca

Coquitlam - Maillardville Decorative Standard

**Candela (CAND1), Domus (DMS50)
on VC6 Bracket**

**PHILIPS
LUMEC**

valmont
WEST COAST ENGINEERING

5.4.1 Street Type 1 (View B)

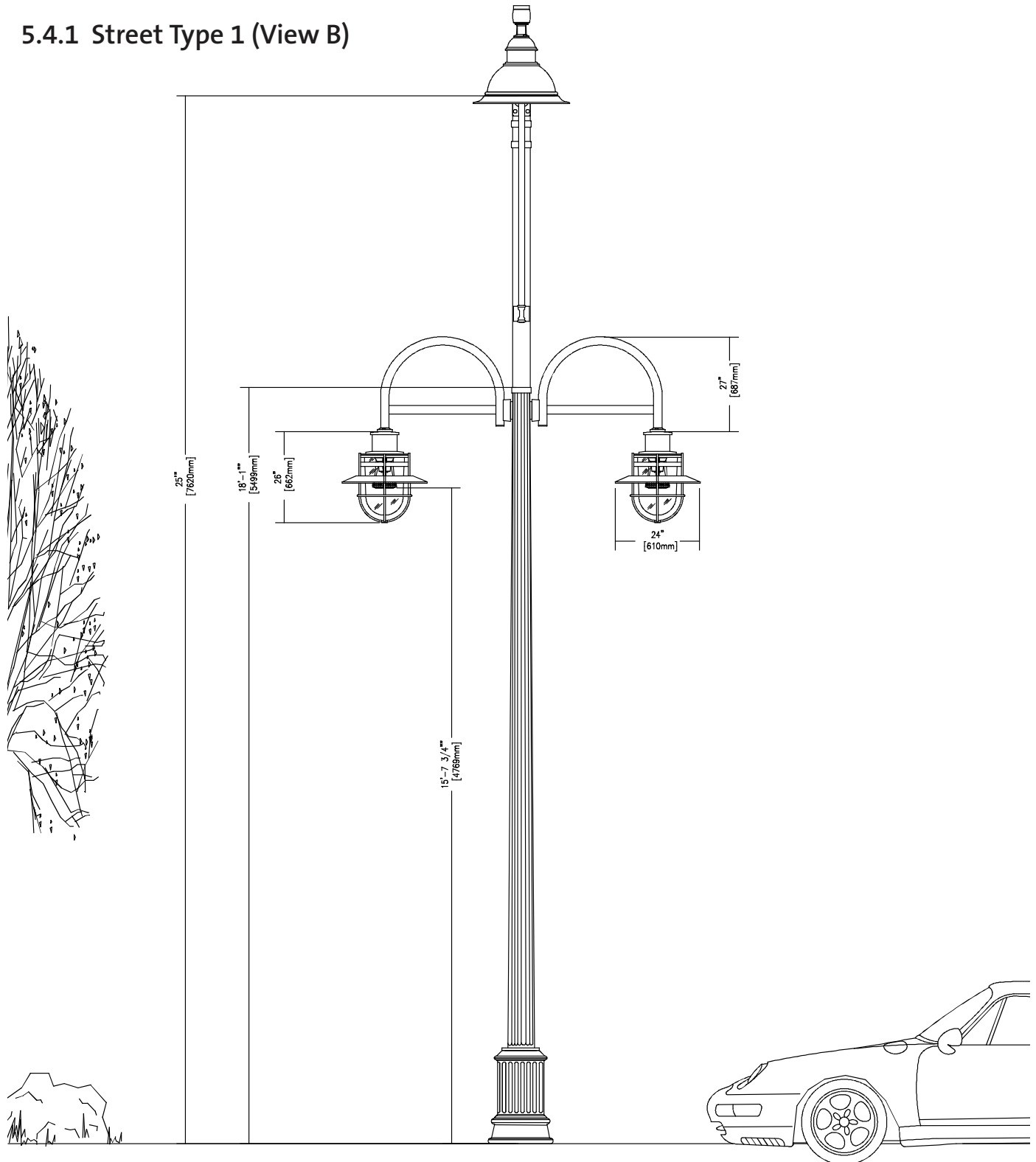

**Metrolume
Lighting System Inc.**

PO Box 12009, RPO Murrayville
Langley, B.C. V3A 9J5
Phone: 778-278-3515 Fax: 778-278-3516
www.metrolume.ca

Coquitlam - Maillardville Decorative Standard

**Candela (CAND1), Domus (DMS50)
on VC6 Bracket**

**PHILIPS
LUMEC**

valmont 
WEST COAST ENGINEERING

5.4.2 Street Type 2

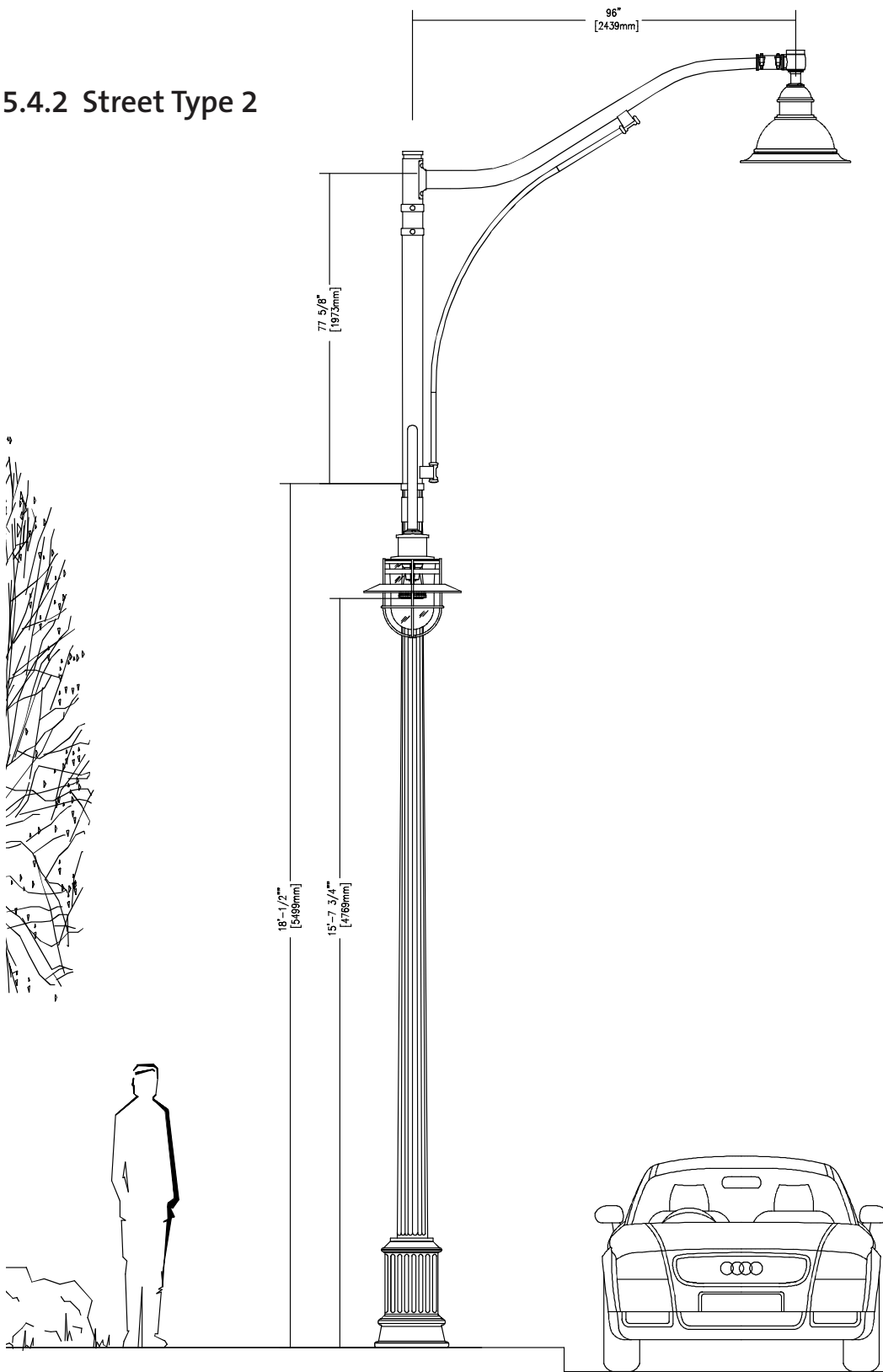

**Metrolume
Lighting System Inc.**

PO Box 12009, RPO Murrayville
Langley, BC, V3A 9J5
Phone: 778-278-3515 Fax: 778-278-3516
www.metrolume.ca

Coquitlam - Maillardville Decorative Standard

**Candela (CAND1), Domus (DMS50)
on VC8 Bracket**

**PHILIPS
LUMEC**

valmont
WEST COAST ENGINEERING

5.4.3 Pedestrian

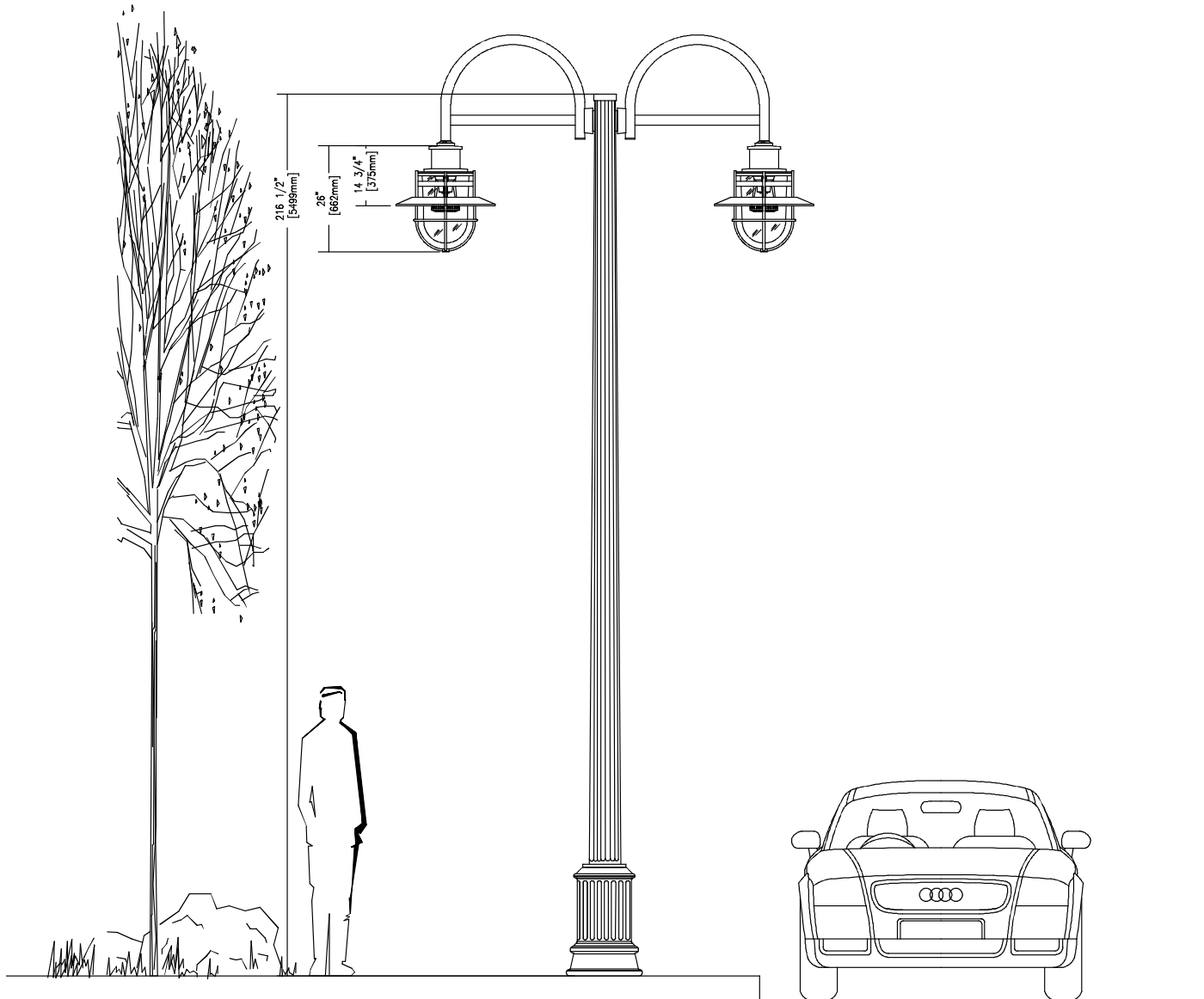

<p>Metrolume Lighting System Inc. PO Box 12009, RPO Murrayville Langley, BC, V3A 9J5 Phone: 778-278-3515 Fax: 778-278-3516 www.metrolume.ca</p>	<p>Coquitlam - Maillardville Decorative Standard</p>	<p>PHILIPS LUMEC</p>
	<p>Candela (CAND1)</p>	<p>valmont  WEST COAST ENGINEERING</p>

5.5 Street Name Signs

Standard Maillardville street name sign blades that existing at some intersections of the neighbourhood, have been adapted to include the neighbourhood brand. These updated sign blade designs combine the City of Coquitlam best practices in terms of colour, font, reflectivity and size for a standard application, but maintain Maillardville’s unique look.

The locations of these updated Maillardville street name signs are identified on Figure 36. Implementation will come about through replacements for lost or damaged street name signs or as capital funding becomes available.



This page intentionally left blank

